

**BRASSEX INC.**

THE FURNITURE PEOPLE

SINCE 1986

# Assembly Instructions Instruction D'Assemblage

Numéro d'article / Item No: C-5351-CR

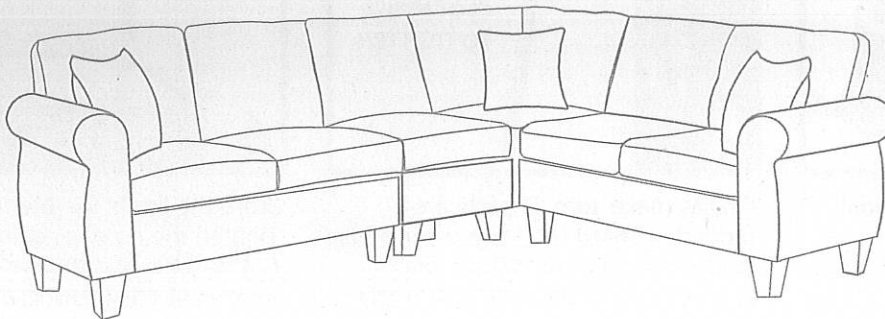
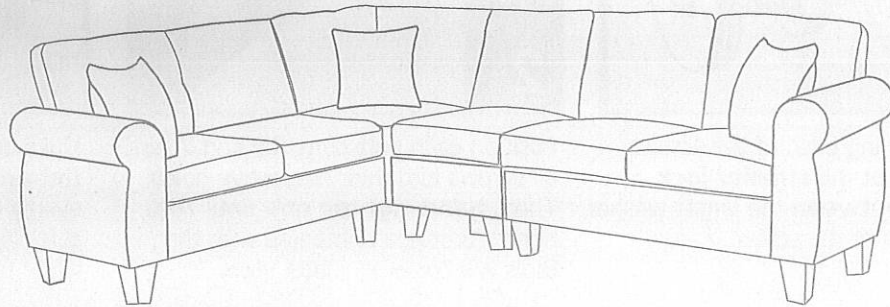

EASY/  
FACILE

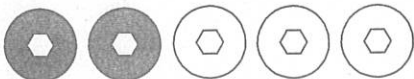

DIFFICULT/  
DIFFICILE

**\*2 Persons recommended /  
\*2 Personnes recommandées**

## ASSEMBLY RATING

The Assembly Rating is a 5-point system that shows the degree of effort needed in assembling a specific product (with 1 being easy and 5 being relatively difficult). For some products, two persons are recommended.

## DIFFICULTE D'ASSEMBLAGE

Le code de montage est un système de 5 points qui montre le degré d'effort nécessaire pour assembler un produit spécifique (1 étant facile et 5 étant relativement difficiles). Pour certains produits, deux personnes sont recommandés.

# \*\* IMPORTANT \*\*

## MUST READ BEFORE ASSEMBLY!

FOR YOUR FURNITURE TO LAST, CORRECT ASSEMBLY AND PROPER MAINTENANCE ARE NECESSARY. PLEASE FOLLOW THE INFORMATION PROVIDED BELOW TO FULLY ENJOY YOUR FURNITURE.

### BASIC ASSEMBLY TECHNIQUES

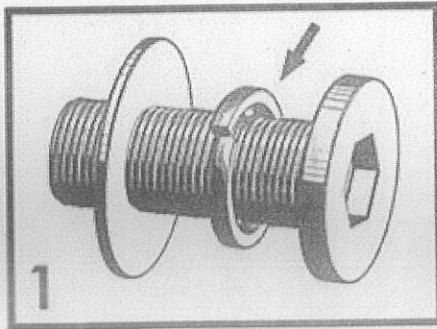

1 Before attaching each of the screws, make sure that the **smaller lock washer is between** the larger washer and the head of the screw.

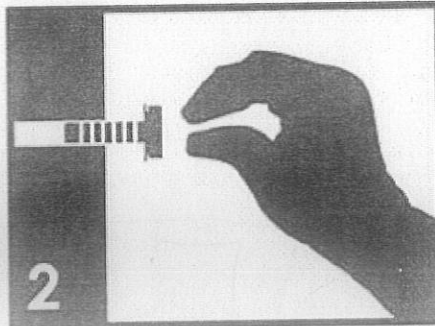

2 Position each part correctly and insert all screws into their respective holes. Then, **hand-tighten** only until 70% tight. Complete tightening with the tools will come at a later step.

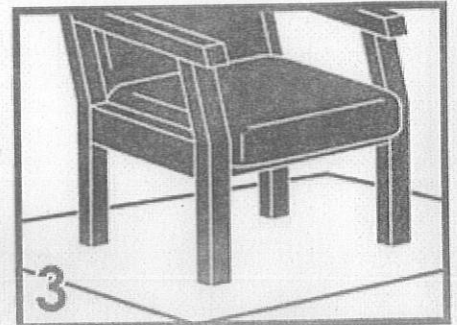

3 Make sure the furniture rests on a **flat and level surface** with each leg evenly touching the ground. Use a soft blanket or carpet underneath when turning the piece on its side.

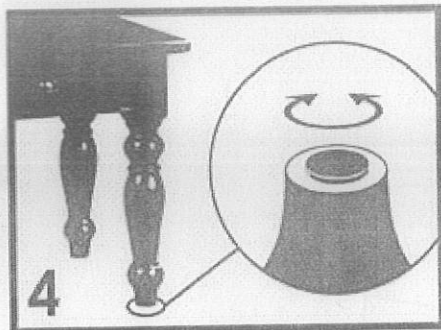

4 Some furniture come with optional **height adjustment knobs** underneath each leg. Turn this knob counterclockwise to raise the leg level or clockwise to lower the leg level.

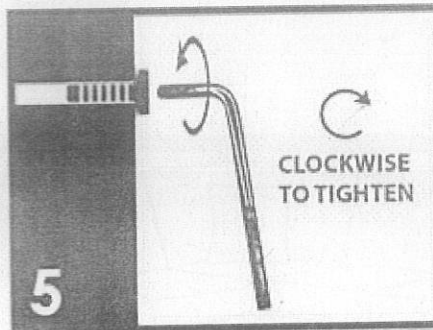

5 Finally, make sure all parts are properly aligned then use the included **tools** to completely tighten the screws. Your furniture is now ready for use.

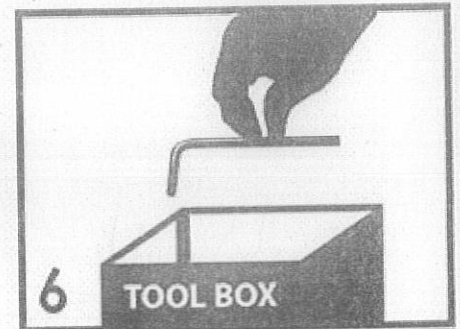

6 Store the **tools** for later maintenance. Tighten the screws again **after two (2) weeks**, and then at least **once every six (6) months** after that.

**IT IS THE USER'S RESPONSIBILITY TO MAINTAIN THE FURNITURE. THE SCREWS MAY LOOSEN OVER TIME AND CAUSE THE FURNITURE TO BE WOBBLY AND UNABLE TO SUPPORT ITS INTENDED WEIGHT CAPACITY. THIS CAN LEAD TO COLLAPSE AND CAN CAUSE SERIOUS INJURY.**

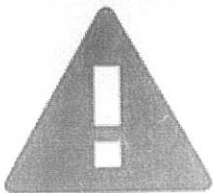

**FAILURE TO FOLLOW THE GUIDELINES ABOVE MAY RESULT IN INJURY AND/OR PROPERTY DAMAGE.**

# **\*\* IMPORTANT \*\***

## **DEVEZ LIRE AVANT ASSEMBLAGE!**

POUR QUE VOTRE MEUBLE DURE LONGTEMPS, IL EST IMPORTANT DE L'ASSEMBLER ET DE L'ENTREtenir CORRECTEMENT. POUR PROFITER PLEINEMENT DE VOTRE MEUBLE, VEUILLEZ SUIVRE LES INDICATIONS CI-DESSOUS.

### **ASSEMBLAGE**

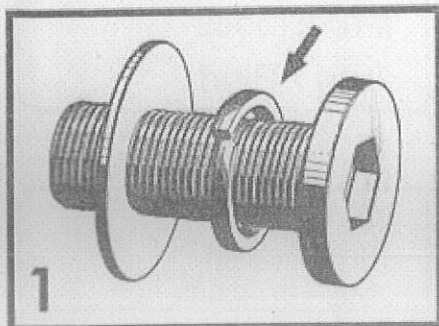

1 Avant de serrer chacune des vis, assurez-vous que la petite rondelle de blocage se trouve en la rondelle plus large et la tête de la vis.

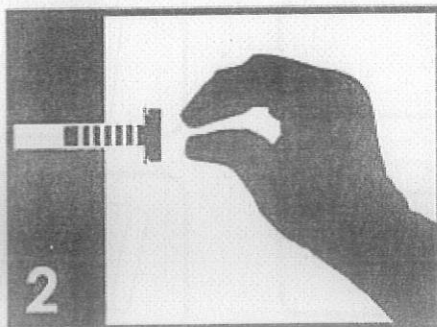

2 Positionnez correctement chacune des pièces et insérez les vis dans leurs orifices respectifs. Puis serrer à la main seulement jusqu'à 70 %. Resserment complète avec les outils viendra à une étape ultérieure.

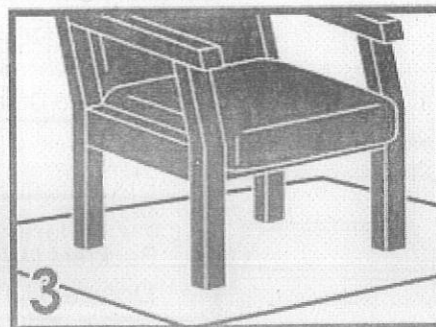

3 Assurez-vous que le meuble repose sur une surface plane et à niveau, que chaque pied touche au sol. Utilisez une couverture douce ou un tapis en dessous en tournant la pièce sur le côté.

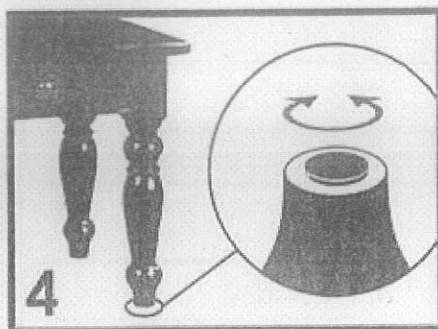

4 Certains meubles sont dotés d'une vis de réglage de la hauteur sous chaque pied. Tournez ce bouton vers la gauche pour augmenter le niveau du pied ou dans le sens horaire pour abaisser le niveau du pied.



5 Une fois que vous êtes assuré que chaque pièce est alignée correctement, utilisez les outils inclus pour bien serrer toutes les vis. Vous pouvez maintenant utiliser votre meuble.

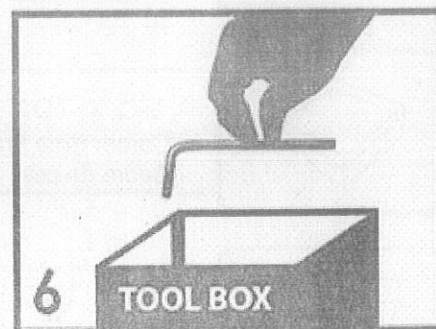

6 Rangez les outils pour réutiliser plus tard, pour effectuer l'entretien de votre meuble. Après deux (2) semaines d'utilisation, serrez de nouveau les vis; serrez-les ensuite au moins une fois tous les six (6) mois.

**L'UTILISATEUR À LA RESPONSABILITÉ DE FAIRE L'ENTRETIEN DE SON MEUBLE. AVEC LE TEMPS, LES VIS PEUVENT SE DESSERRER; LE MEUBLE PEUT DEVENIR BANCAL ET NE PAS POUVOIR SUPPORTER SA CHARGE NOMINALE. CETTE SITUATION PEUT CAUSER UNE CHUTE ET DES BLESSURES GRAVES.**



**LE FAIT DE NE PAS RESPECTER LES CONSIGNES CI-DESSUS PEUT ENTRAÎNER DES BLESSURES OU DES DOMMAGES.**

## PARTS IDENTIFICATION / IDENTIFICATION DES PIÈCES

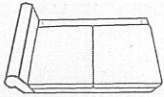

**#1 x 1pc**  
Left Loveseat /  
Causeuse Gauche

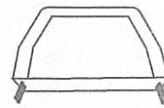

**#9 x 1pc**  
Chair Backrest /  
Dossier de chaise

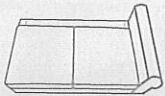

**#2 x 1pc**  
Right Loveseat /  
Causeuse Droite



**#10 x 16pcs**  
Leg / Pied

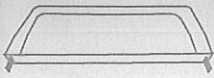

**#3 x 1pc**  
Backrest (L) /  
Dossier (L)

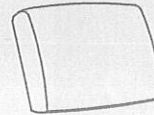

**#11 x 3pcs**  
Back Cushion /  
Coussin de dos

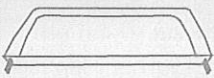

**#4 x 1pc**  
Backrest (R) /  
Dossier (R)

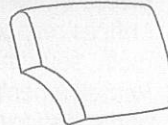

**#12 x 1pc**  
Sofa back cushion (L) /  
Coussin de dos du sofa (L)

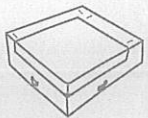

**#5 x 1pc**  
Corner Sofa Frame /  
Cadre de coin

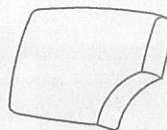

**#13 x 1pc**  
Sofa back cushion (R) /  
Coussin de dos du sofa (R)

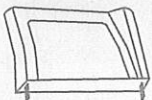

**#6 x 1pc**  
Corner Backrest (L) /  
Coin Dossier (L)

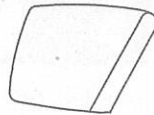

**#14 x 1pc**  
Corner Left Back Cushion /  
Coussin de dos gauche pour coin

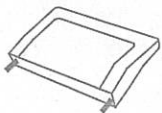

**#7 x 1pc**  
Corner Backrest (R) /  
Coin Dossier (R)

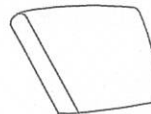

**#15 x 1pc**  
Corner Right Back Cushion /  
Coussin de dos droite pour coin



**#8 x 1pc**  
Chair Seat Cushion /  
COUSSIN DE SIÈGE

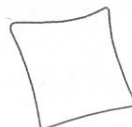

**#16 x 3pcs**  
Pillow / Coussins

STEP 1  
ÉTAPE 1

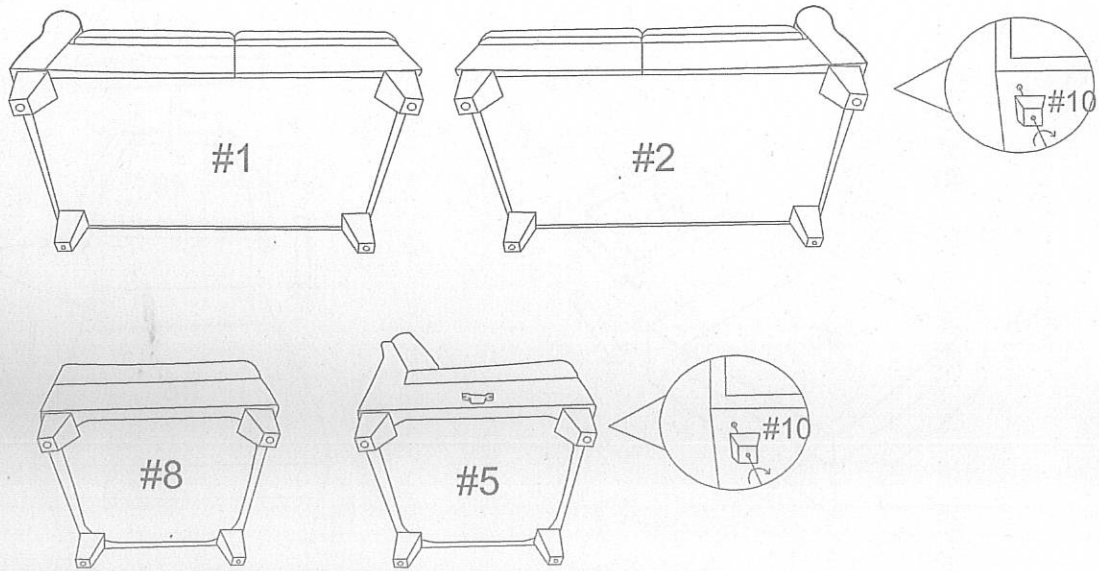

STEP 2  
ÉTAPE 2

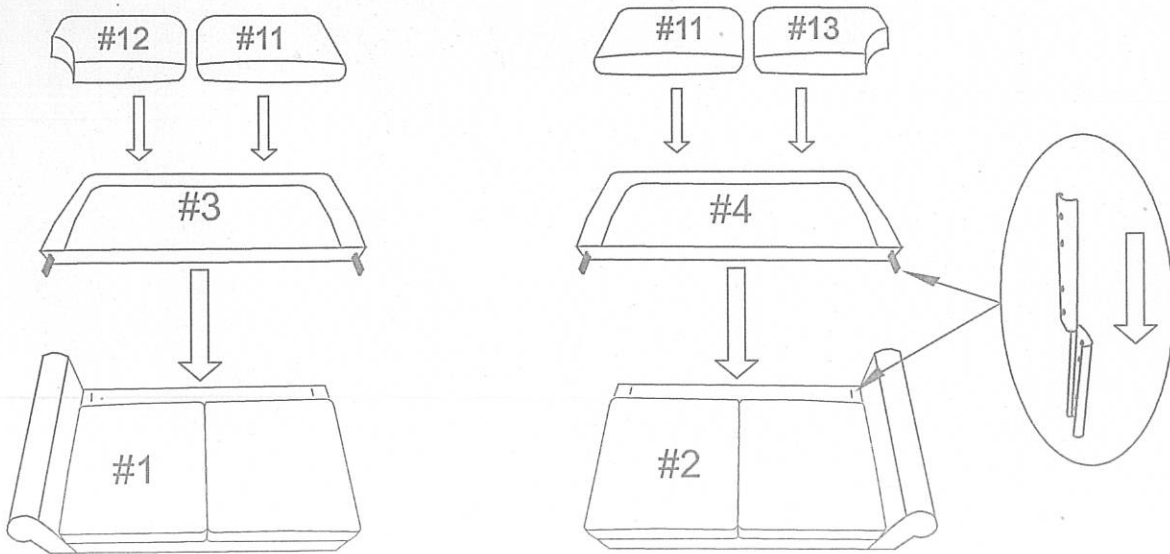

STEP 3  
ÉTAPE 3

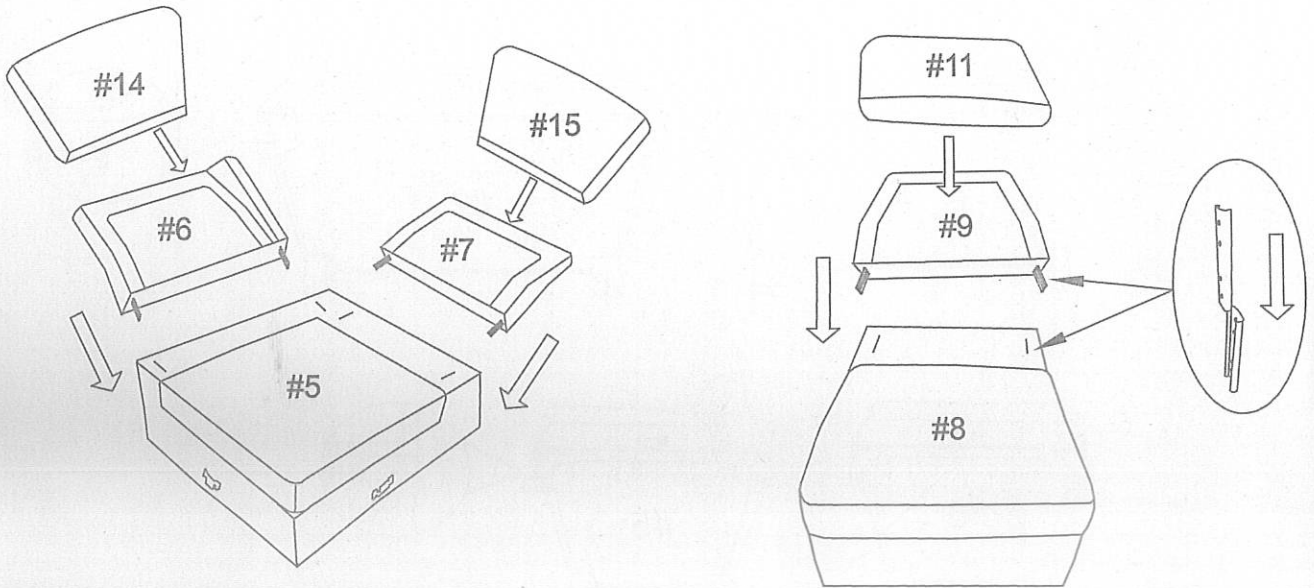

STEP 4  
ÉTAPE 4

