

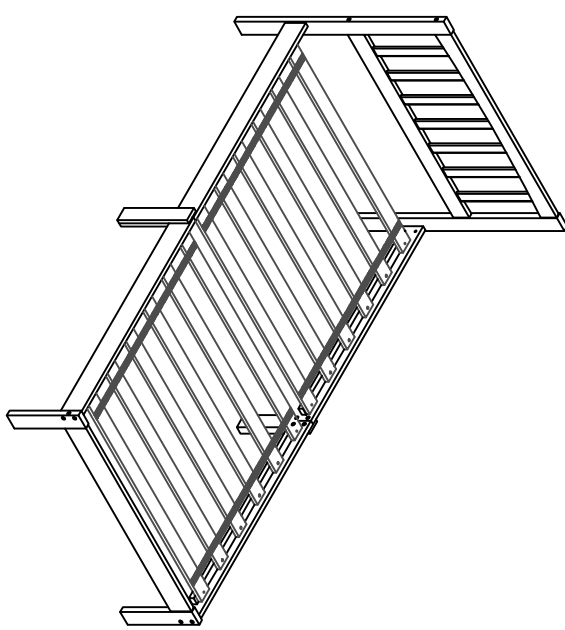

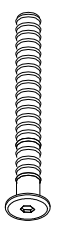

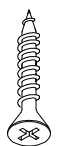

ASSEMBLY INSTRUCTIONS

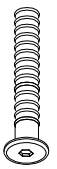

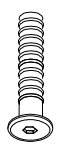
HARDWARE LIST

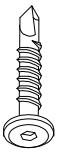
1		6 PCS	5		16 PCS
JCBC	M6 x 100mm	8 PCS	WOOD SCREW 4.0 x 30mm	14 PCS	
2		8 PCS	6		8 PCS
JCBC	M6 x 60mm	8 PCS	BARREL NUT M6 x 13mm	8 PCS	
3		8 PCS	7		1 PC
JCBC	M6 x 30mm	8 PCS	WOOD DOWEL Ø10 x 30mm	1 PC	
4		8 PCS	8		1 PC
JCBC-W	M6 x 30mm	8 PCS	M 4 ALLEN KEY	1 PC	

ASSEMBLY TIPS









1. Remove hardware from box and sort by size.
2. Please check to see that all hardware and parts are present prior start of assembly.
3. Please follow attached instructions in the same sequence as numbered to assure fast and easy assembly.

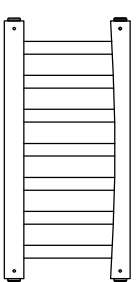

Warning !

1. Don't attempt to repair or modify parts that are broken or defective. Please contact the store immediately.
2. This product is for home use only and not intended for commercial establishments.

COMPONENT LIST

A		1 PC	F		1 PC
HEADBOARD LEG (LEFT)		1 PC	HEADBOARD PANEL		
B		1 PC	G		2 PCS
HEADBOARD LEG (RIGHT)		1 PC	RIGHT SIDE RAIL		
C		1 PC	H		2 PCS
FOOTBOARD LEG (LEFT)		1 PC	LEFT SIDE RAIL		
D		1 PC	I		2 PCS
FOOTBOARD LEG (RIGHT)		1 PC	CENTER LEG		
E		1 PC	J		2 SETS
FOOTBOARD PANEL		1 PC	SLAT		

