

# ASSEMBLY INSTRUCTIONS / INSTRUCTIONS D'ASSEMBLAGE – DJ1001Q

## ASSEMBLY TIPS:

- 1: Remove hardware from box and sort by size.
- 2: Please check to see that all hardware and parts are present prior to start of assembly.
- 3: Please follow attached instructions in the same sequence as numbered to assure fast & easy assembly

⚠ warning







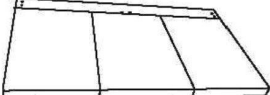
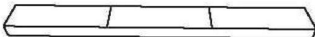

- 1: Don't attempt to repair or modify parts that are broken or defective please contact the store immediately.
- 2: This product is for home use only and not intended for commercial establishment.

1. Retirez la boulonnerie de la caisse et triez par taille.
2. Avant de procéder à l'assemblage, veuillez vérifier que toute la boulonnerie et toutes les pièces sont présentes.
3. Pour assurer un assemblage rapide et facile, veuillez suivre les instructions dans le même ordre que la numérotation







⚠ Avertissement

1. Ne pas essayer de réparer ou de modifier les pièces qui sont cassées ou défectueuses. Veuillez communiquer immédiatement avec le magasin.
2. Ce produit est conçu pour être utilisé uniquement à la maison et n'est pas destiné aux établissements commerciaux, quels qu'ils soient.

## PARTS / IDENTIFICATION DES PIÈCES

A		1PC
B		1PC
C		2PCS
D		1PC
E		2PCS
F		26PCS
G		4PCS
H		26PCS
I		13PCS
P	 Anti-skid rubber	4PCS

## HARDWARE / IDENTIFICATION DU KIT

NO	SPECIFICATION	SHAPE	QTY
J	M8*16MM		18PCS
K	M8		18PCS
L	M5 (100*40mm)		1PC
M	M8*30mm		4PCS
N	M8 (32MM)		14PCS
O	M8 (90mm)		4PCS

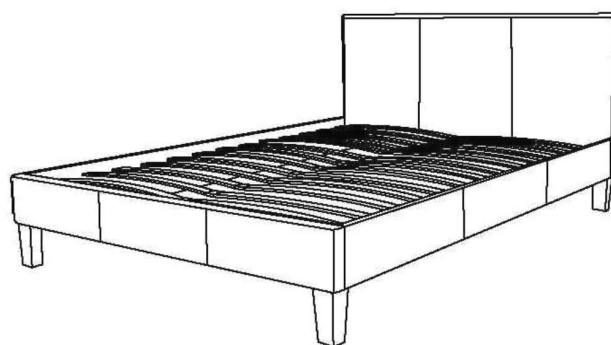

# STEP 1 / ÉTAPE 1

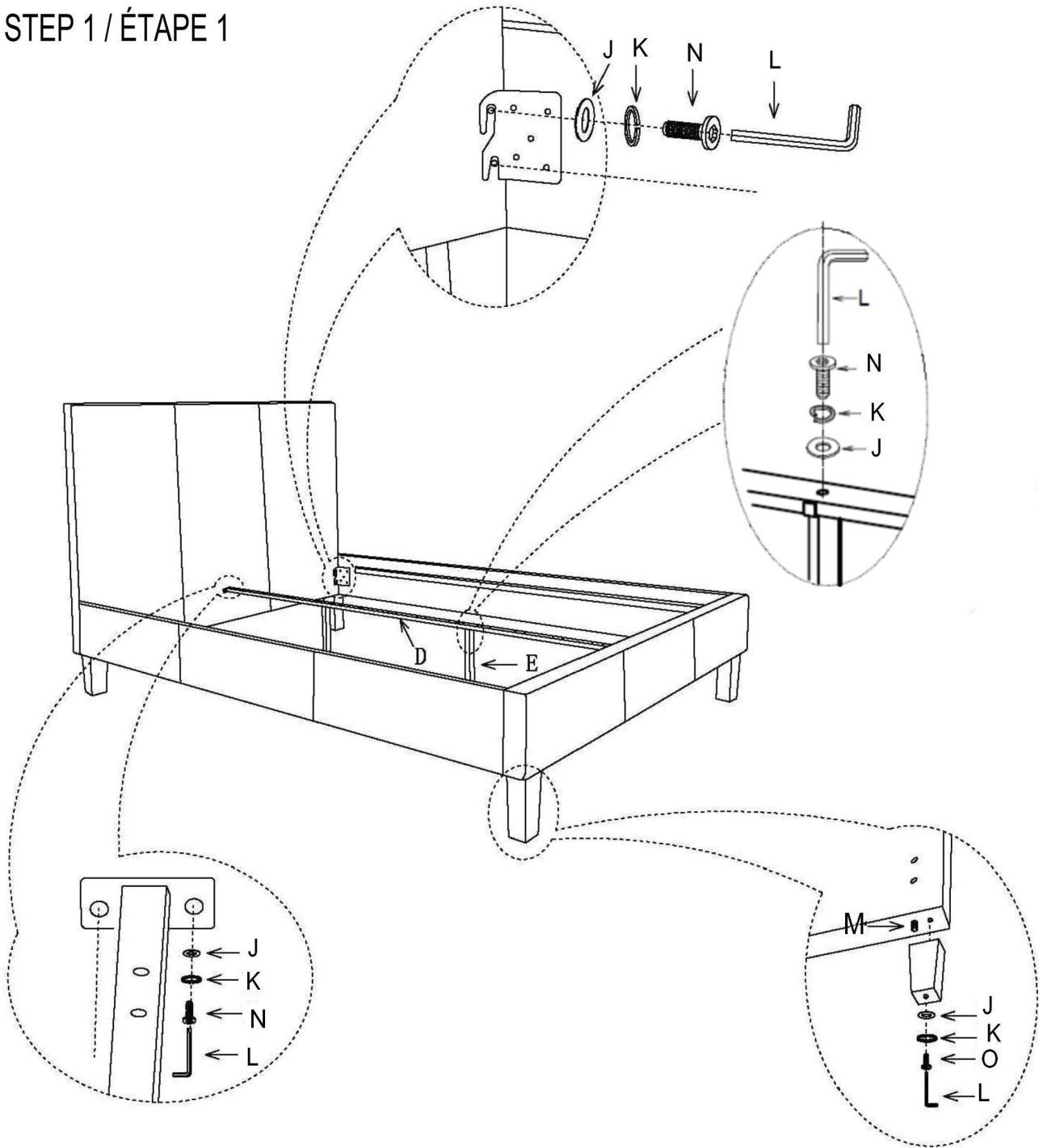

# STEP 2 / ÉTAPE 2

