

Step 3.

Embed support slats (4) into side rails (5) .

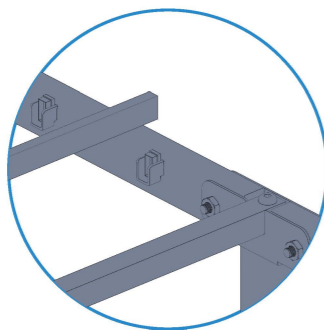

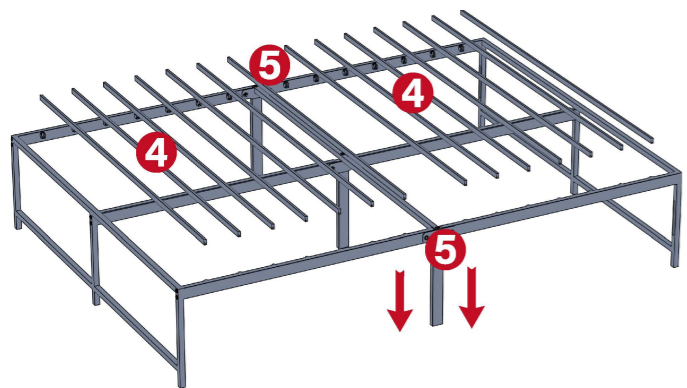







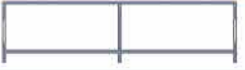

WARNING

- Due to the size of this bed we recommend assembling it in the room intended for use.
- Use on firm, level ground. To avoid scratching to the floor, please assemble it on a blanket or a carpet.
- Check the packaging to make sure you have all the parts listed on this instruction.
- Do not tighten all screws until finish.
- Do not destroy the packaging until after the product is fully assembled.
- Keep all packaging box, bags, and small parts out of the reach of children.
- Make sure bed frame's legs are in contact with the ground all the time.
- Do not jump, stand on this bed.
- To move this bed, please disassemble firstly.

User Manual
Metal Bed Frame

Components

1		Head Rail	1 pc.
2		Foot Rail	1 pc.
3		Center Slat	1 pc.
4		Support Slats	14 pcs.
5		Side Rails	2 pcs.
6		Center Support Rail	1 pc.
A		A: Bolts-M8x35mm	12 pcs.
B		B: Bolts-M8x50mm	2 pcs.
C		C: Long Bolts-M8x70mm	1 pc.
D		Wrench	1 pc.

Note: Please confirm that you received all parts and accessories before assembly.

Available in Full, Queen size

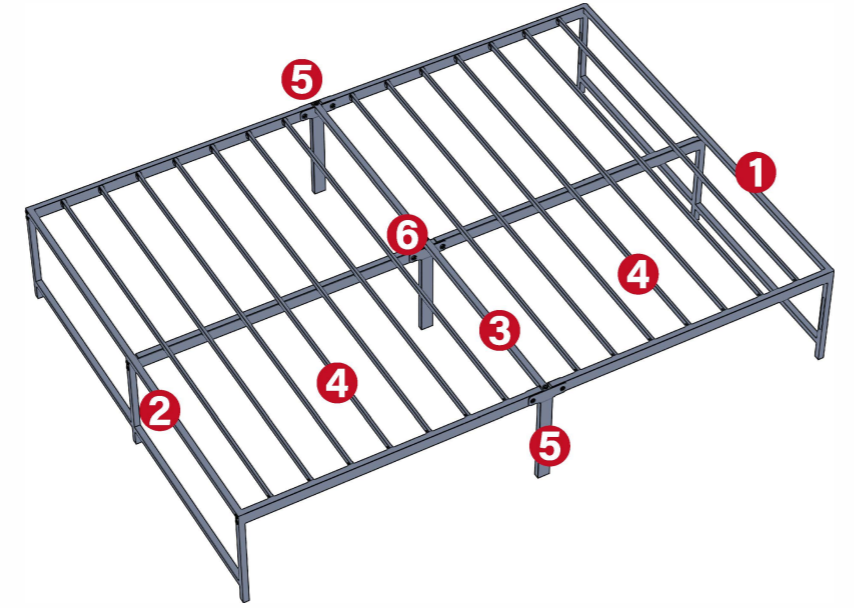

Step 1.

Attach headrail (1) and footrail (2) to side rails (5) & Center Support Rail (6) with bolt A.

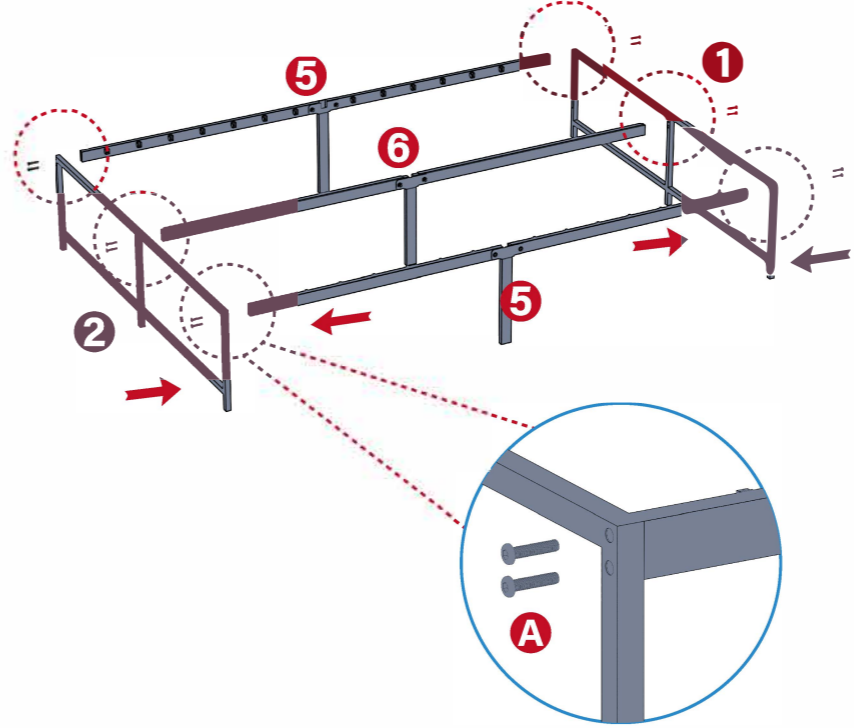

Step 2.

Embed centerslat (3) into side rails (5) & Center Support Rail (6) with bolt B&C.

