

OFFICE CHAIR ASSEMBLY INSTRUCTION

CHAISE DE BUREAU INSTRUCTIONS D'ASSEMBLAGE

ASSEMBLY PROGRAM / PROGRAMME D'ASSEMBLAGE

PARTS*QTY / PIÈCES*QTÉ

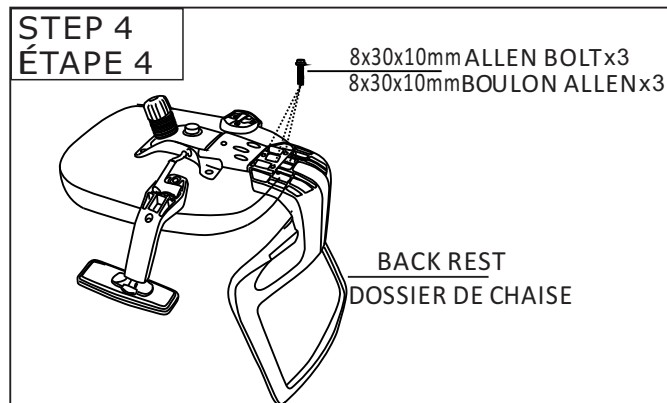
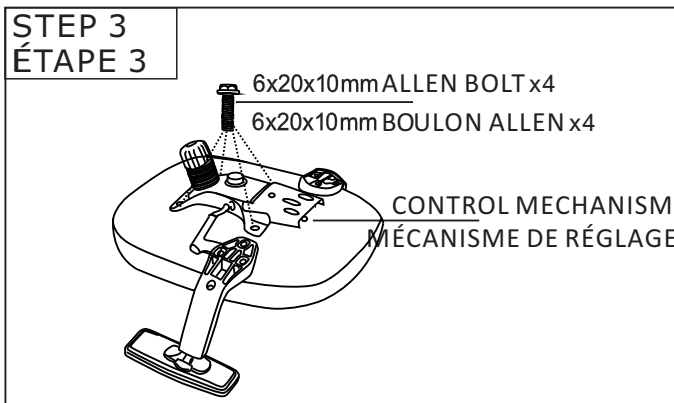
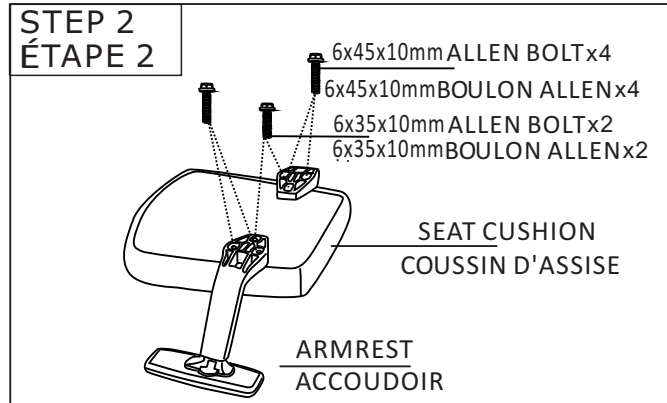
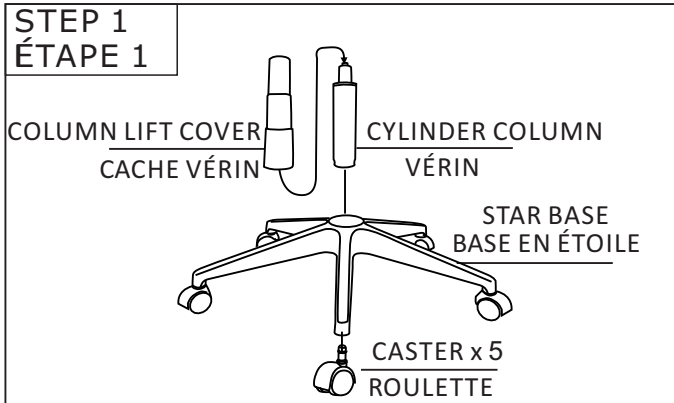

BACK REST x1 DOSSIER DE CHAISE x1	CASTER x5 ROULETTE x5
SEAT CUSHION x1 COUSSIN D'ASSISE x1	6x20x10mm ALLEN BOLT x4 6x20x10mm BOULON ALLEN x4
ARMREST x2 ACCOUDOIR x2	6x35x10mm ALLEN BOLT x2 6x35x10mm BOULON ALLEN x2
CONTROL MECHANISM x1 MÉCANISME DE RÉGLAGE x1	6x45x10mm ALLEN BOLT x4 6x45x10mm BOULON ALLEN x4
CYLINDER COLUMN x1 VÉRIN x1	8x30x10mm ALLEN BOLT x3 8x30x10mm BOULON ALLEN x3
STAR BASE x1 BASE EN ÉTOILE x1	COLUMN LIFT COVER x1 CACHE VÉRIN x1
	ALLEN WRENCH x1 CLÉ ALLEN x1