

ITEM NUMBER / NO. ARTICLE: 192015

ASSEMBLY INSTRUCTIONS / INSTRUCTIONS D'ASSEMBLAGE

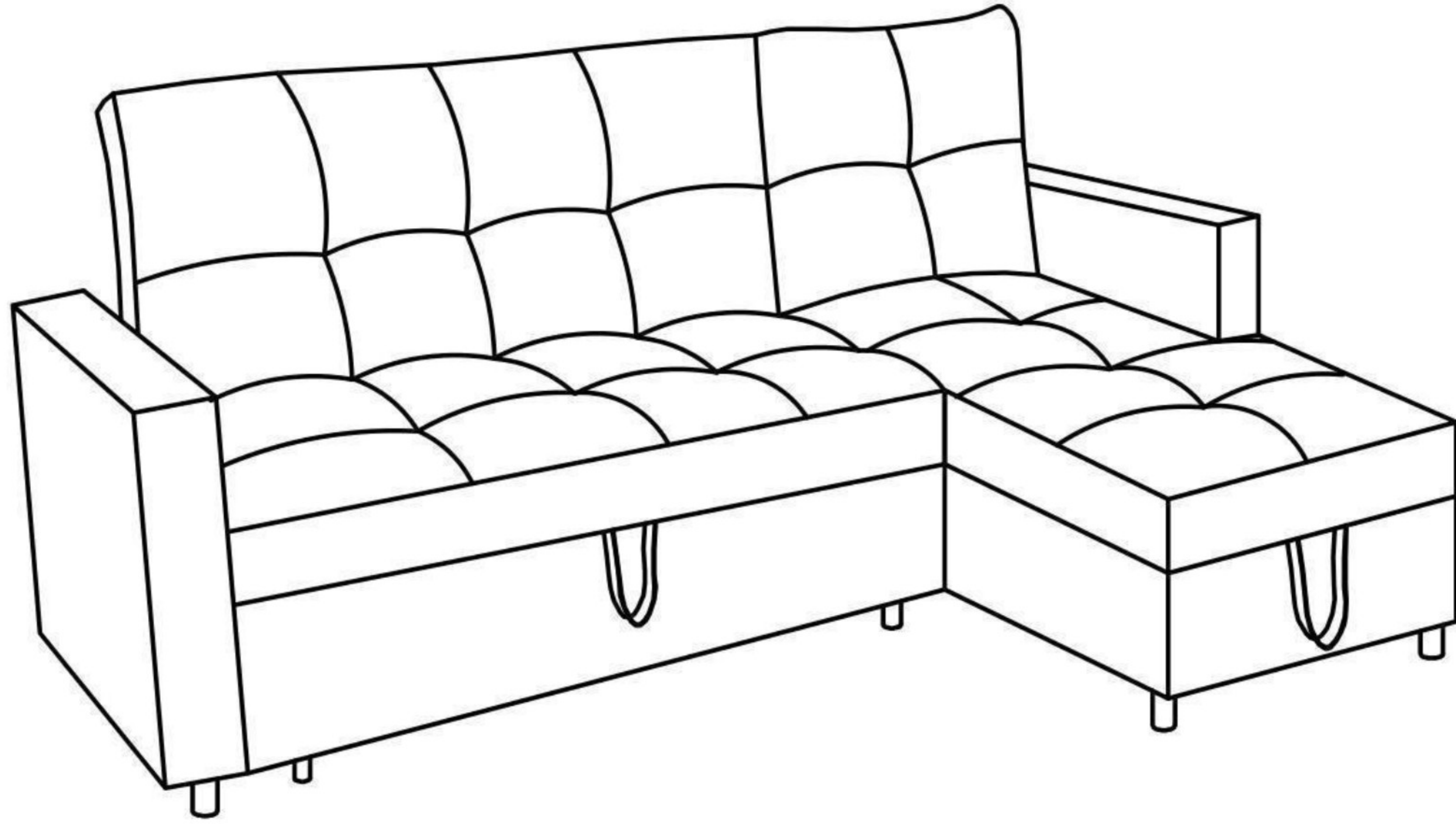

PARTS AND HARDWARE / IDENTIFICATION DES PIÈCES



A : CHAISE / CHAISE 1 PC B : LOVE SEAT / CAUSEUSE 1 PC C : PARTS / PIÈCES 4 PCS

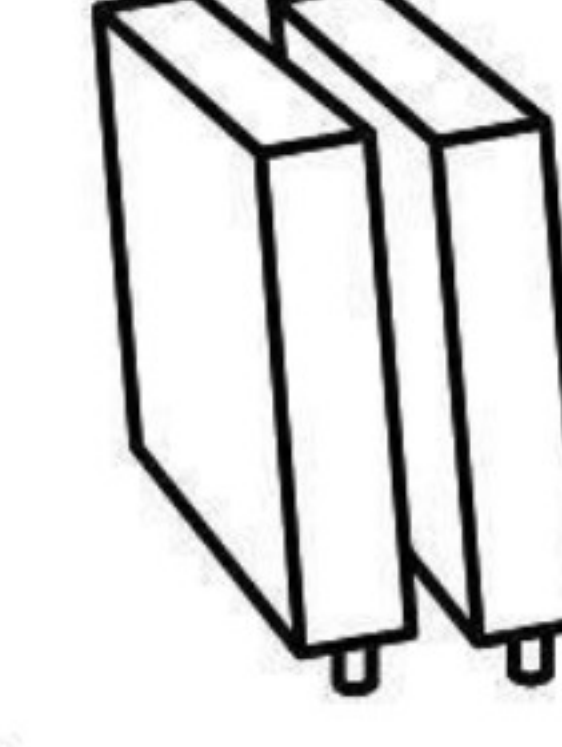

D : ARM / BRAS 2 PCS

E : PARTS / PIÈCES 2 PCS

F : LEG / PEID 4 PCS

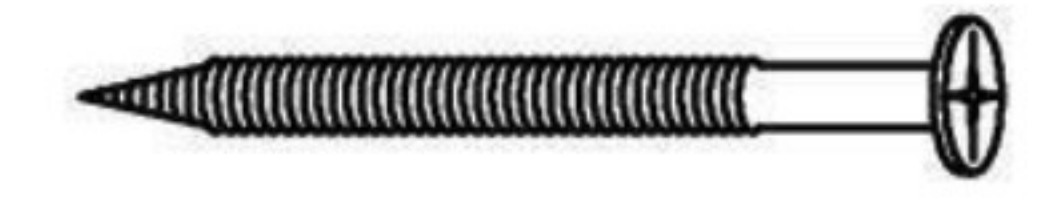

G : SCREWDRIVER / TOURNEVIS 1 PC

H : SCREW / VIS 4 PCS

IMPORTANT NOTE / NOTE IMPORTANTE:

\*\* PLACE ALL PARTS ON A CLEAN AND SMOOTH SURFACE SUCH AS A RUG OR SURFACE TO AVOID THE PARTS FROM BEING SCRATCHED. / PLACEZ TOUTES LES PARTIES SUR UNE SURFACE PROPRE ET LISSE, COMME UN TAPIS OU UNE SURFACE, AFIN D'ÉVITER QUE LES PIÈCES SOIENT RAYÉES.

\*\* BEFORE YOU BEGIN, KINDLY FOLLOW THE ASSEMBLY INSTRUCTIONS STEP BY STEP. / AVANT DE COMMENCER, SUIVRE SENSIBLEMENT LES INSTRUCTIONS DE MONTAGE ÉTAPE PAR ÉTAPE.

\*\* DO NOT TIGHTEN ALL SCREWS UNTIL THE SOFA IS FULLY SET UP. / NE SERREZ PAS TOUTES LES VIS JUSQU'À CE QUE LE CANAPÉ SOIT ENTIÈREMENT INSTALLÉ.

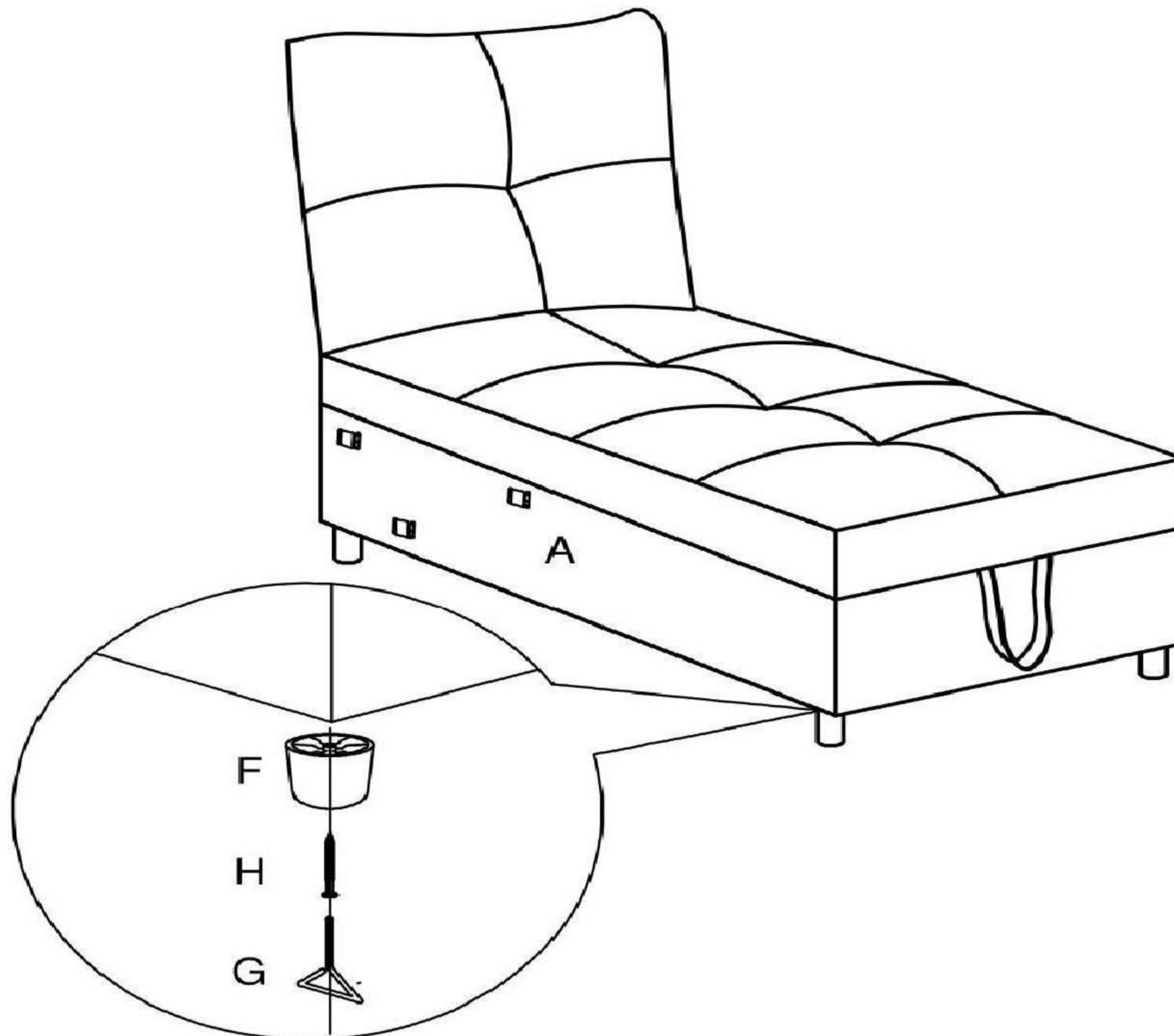

STEP 1 / ÉTAPE 1 :

FIX THE LEGS TO THE CHAISE / FIXER LES PATTES À LA CHAISE

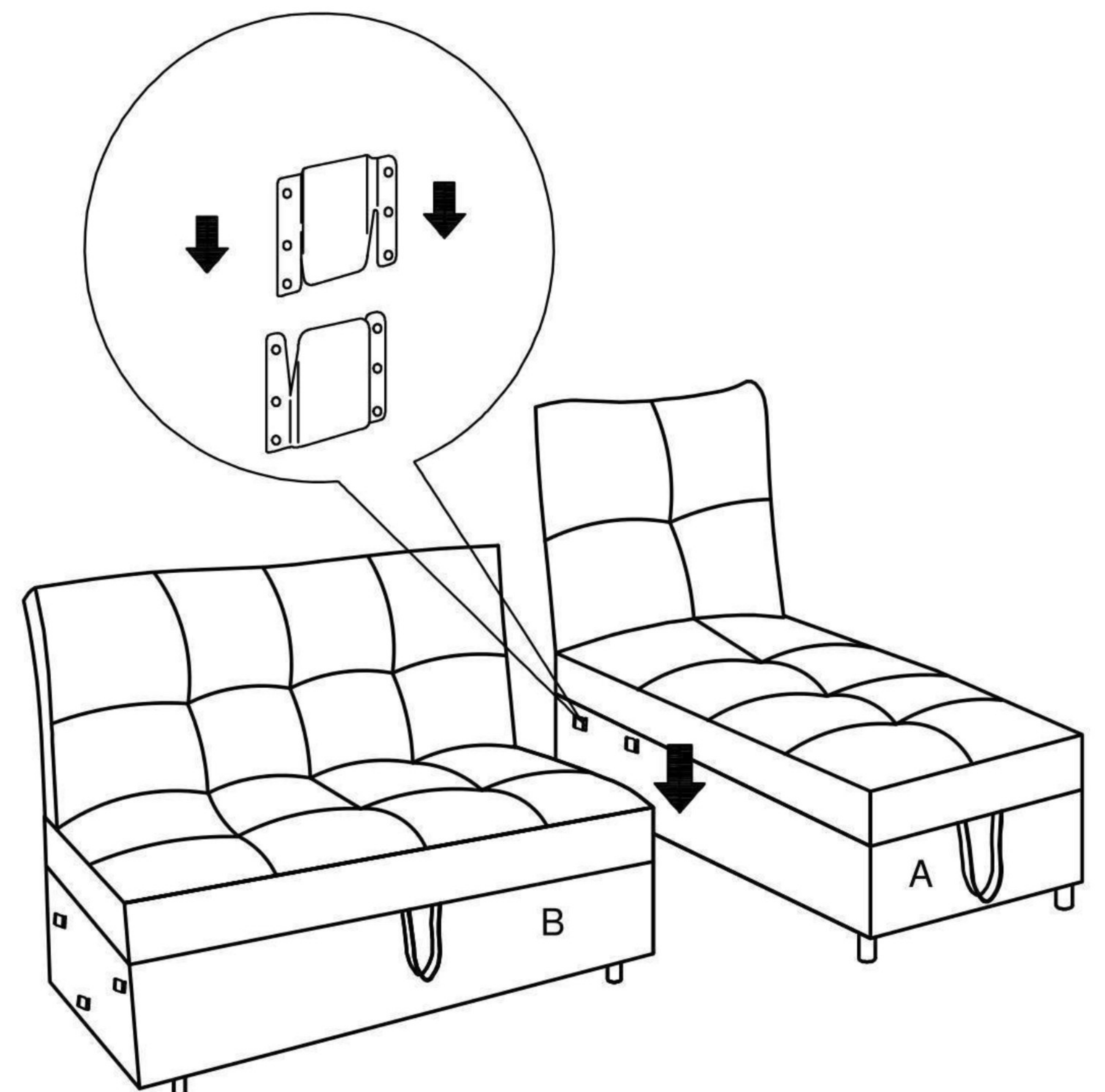
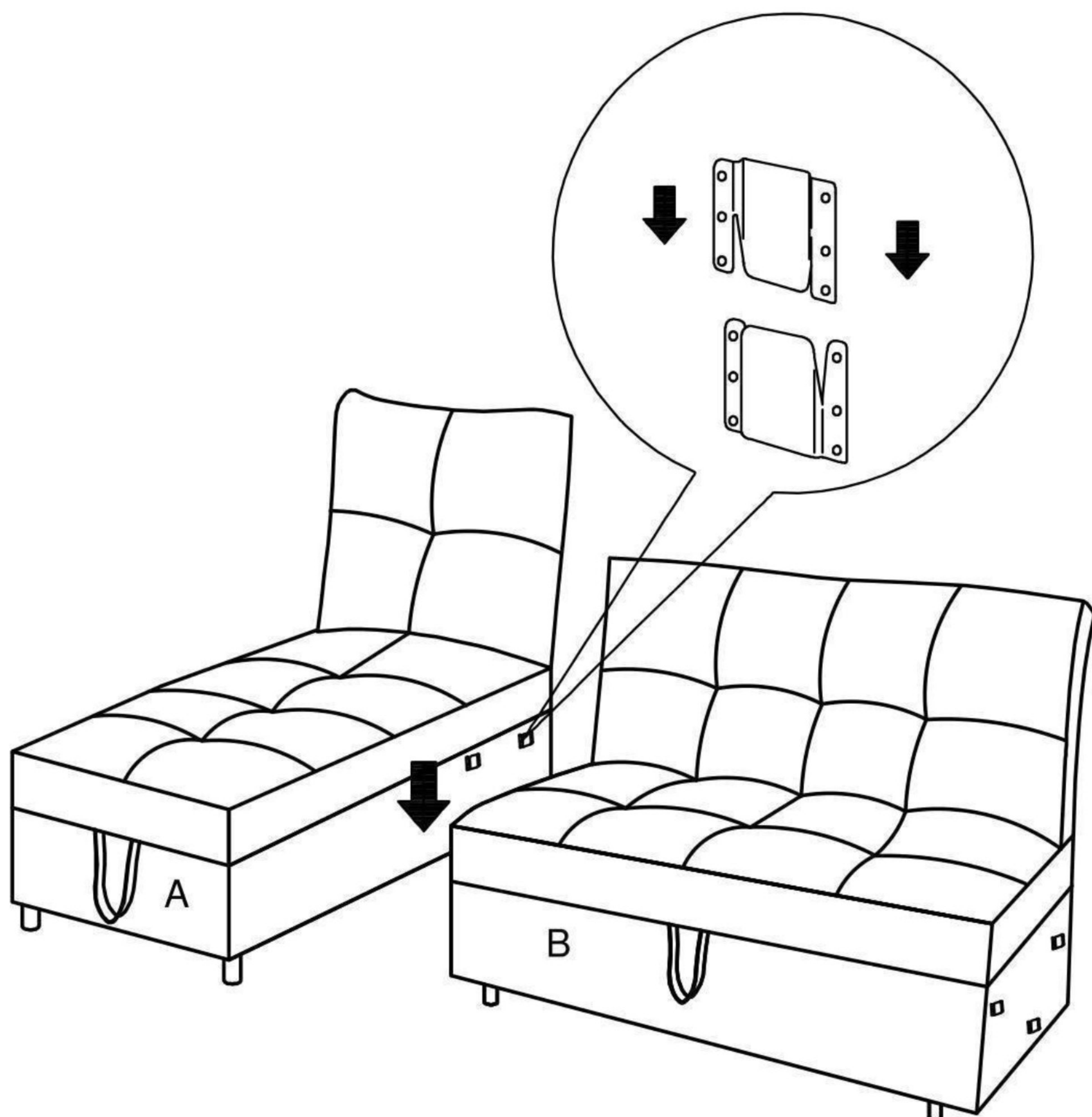

STEP 2 / ÉTAPE 2:

FIX THE LOVE SEAT TO THE CHAISE / FIX LE SIÈGE D'AMOUR À LA CHAISE

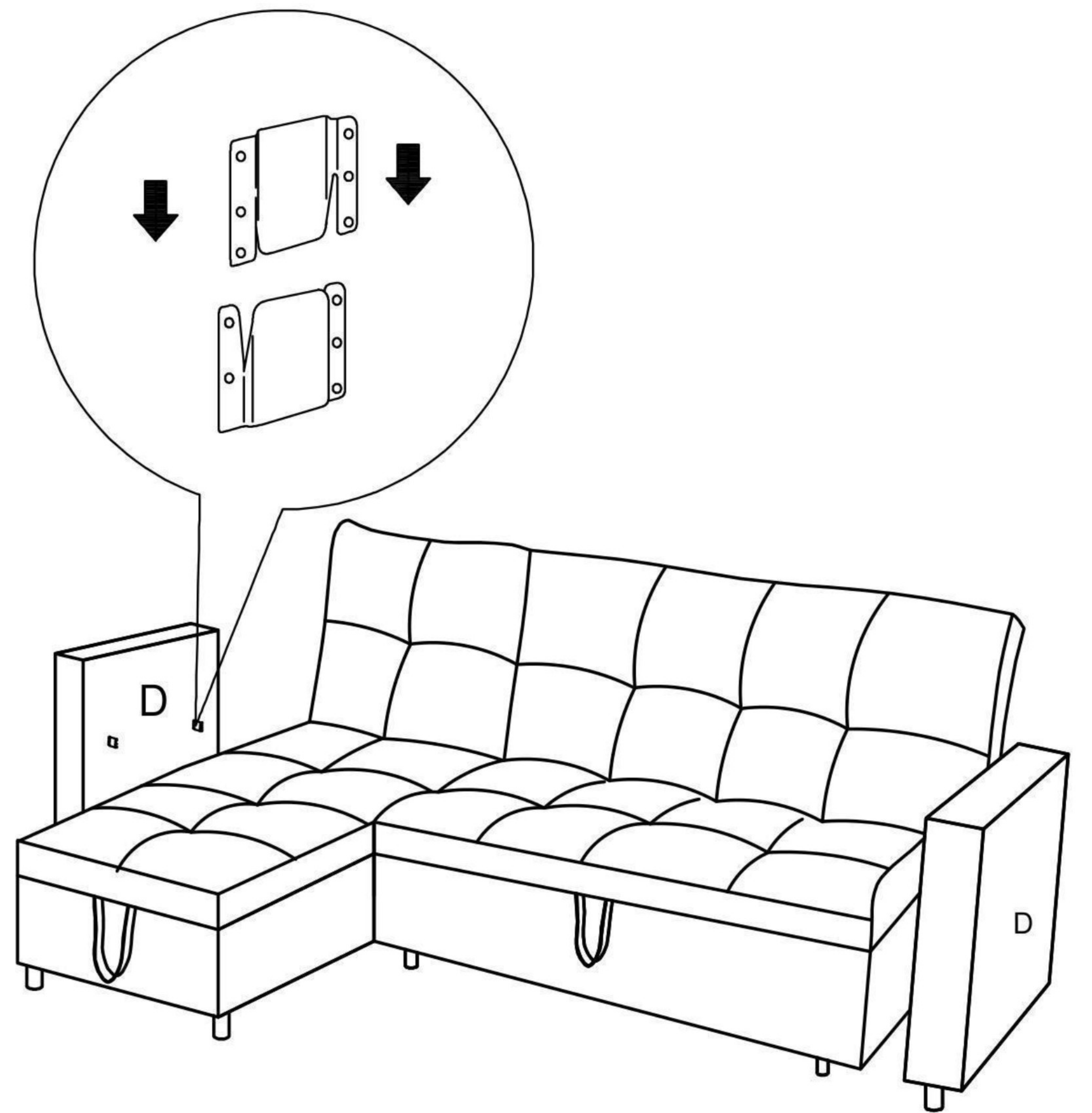
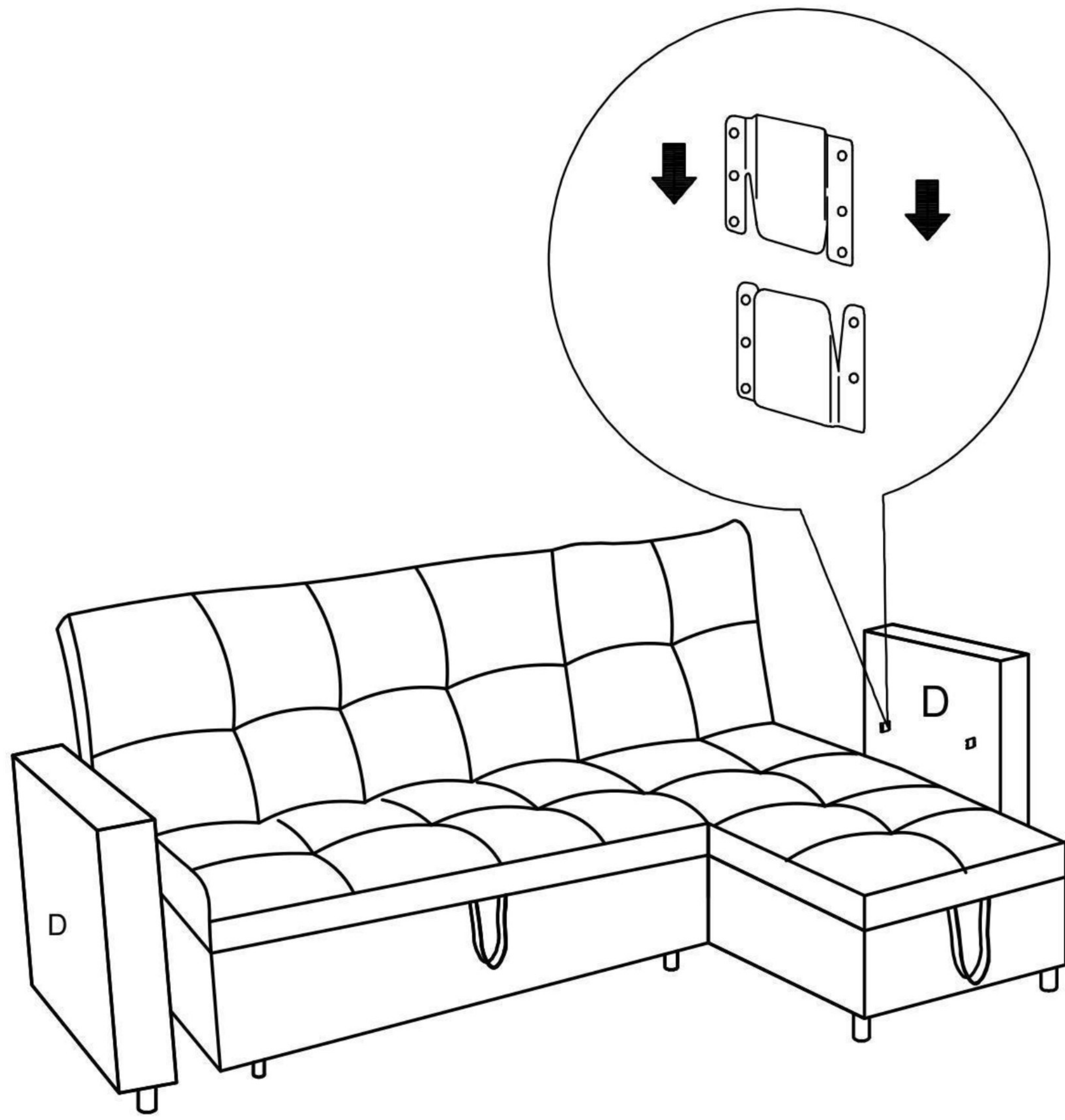

**STEP 3 / ÉTAPE 3 :**

FIX THE ARMS TO THE SOFA / FIXER LES BRAS AU CANAPÉ

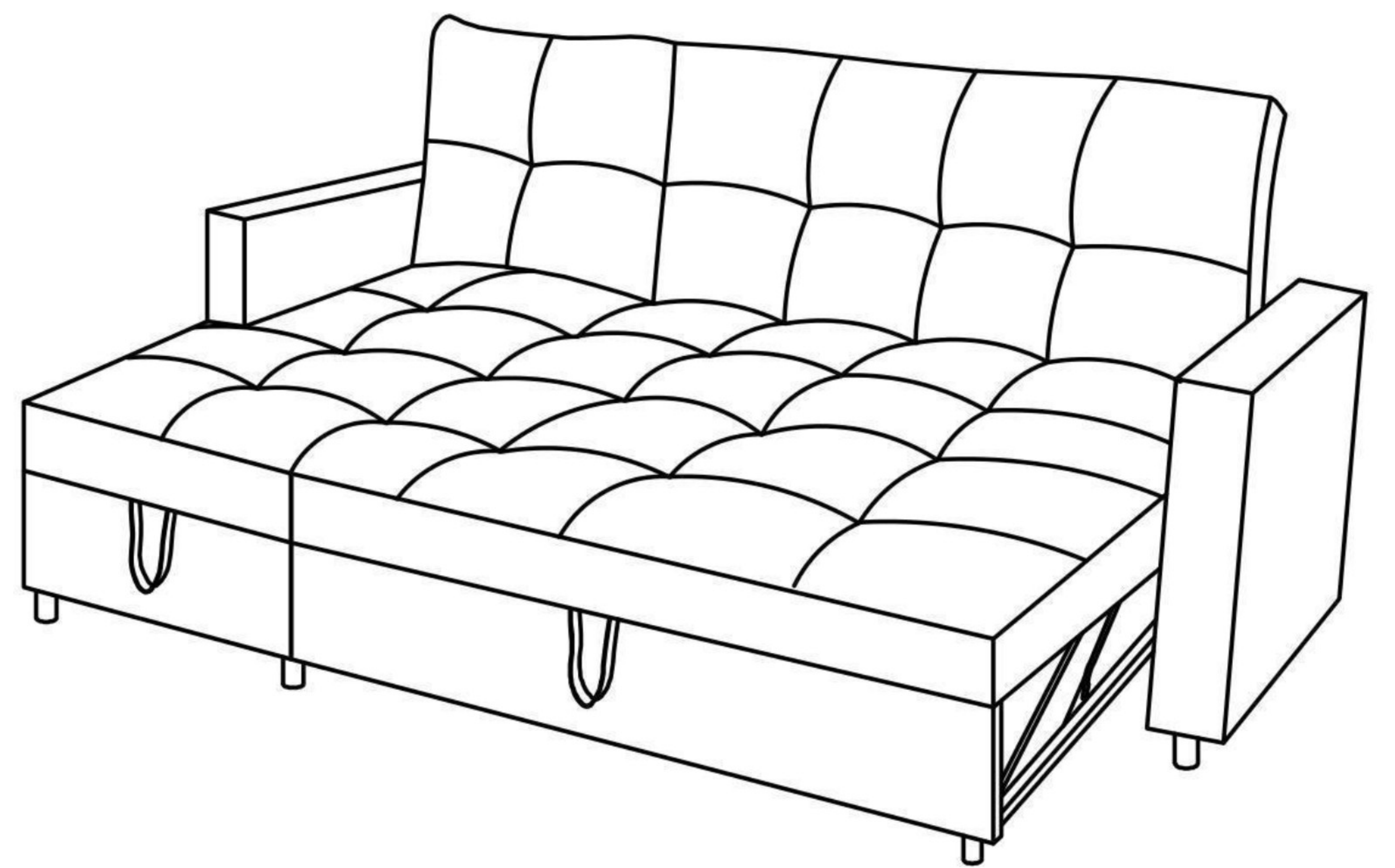
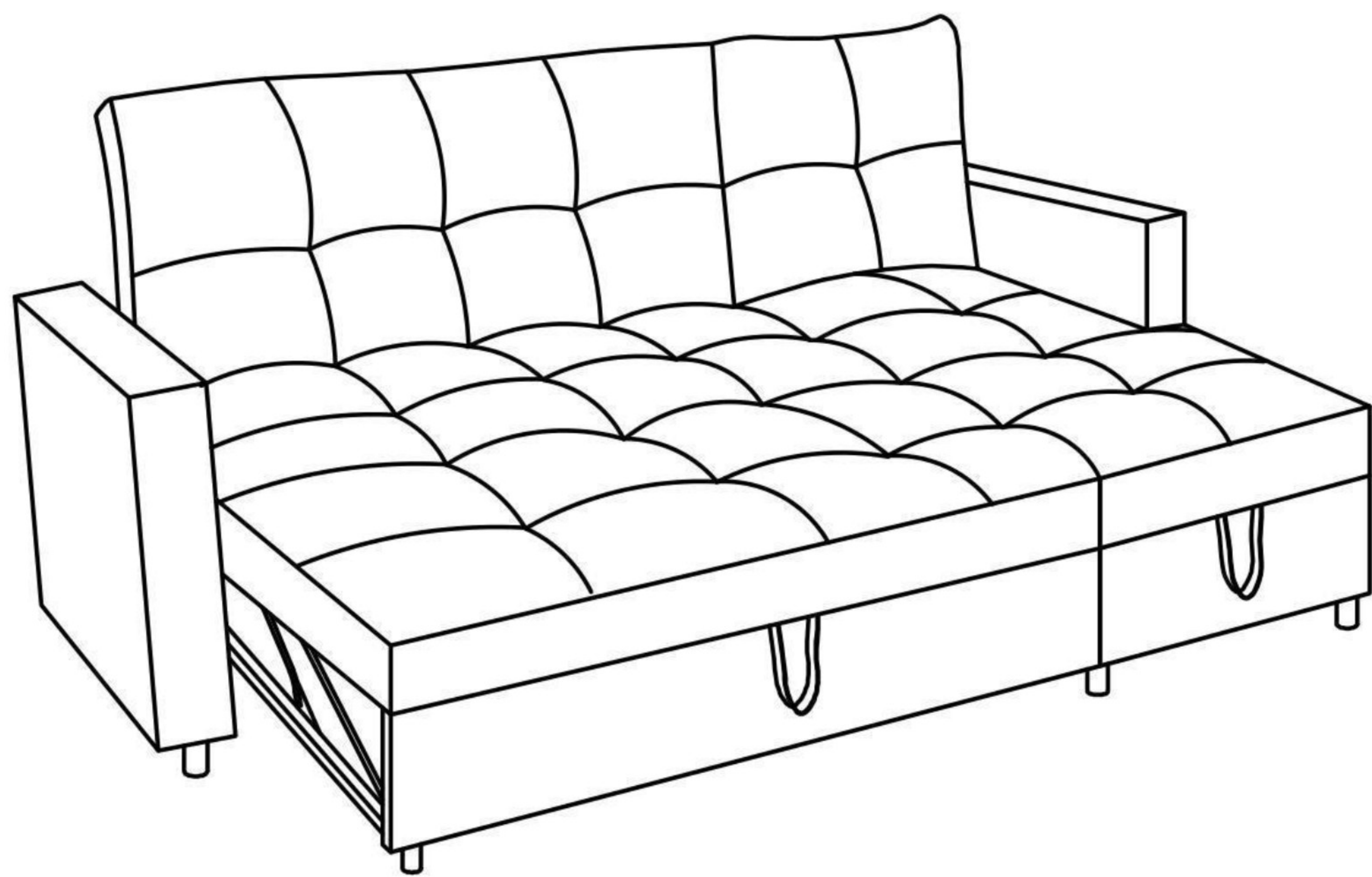

**STEP 4 / ÉTAPE 4 :**

PUT THE PILLOWS TO THE SOFA / METTRE LES OREILLERS SUR LE CANAPÉ

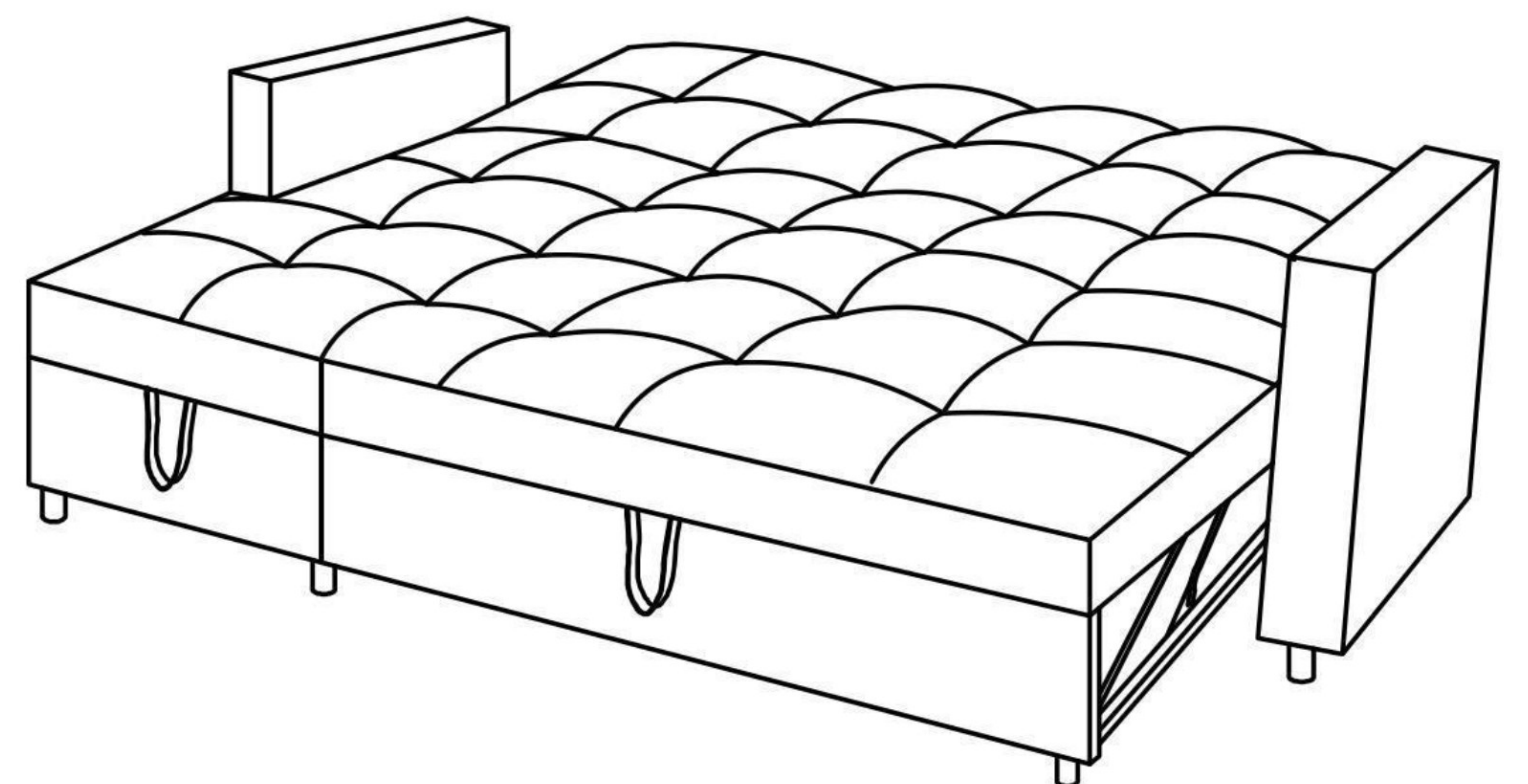
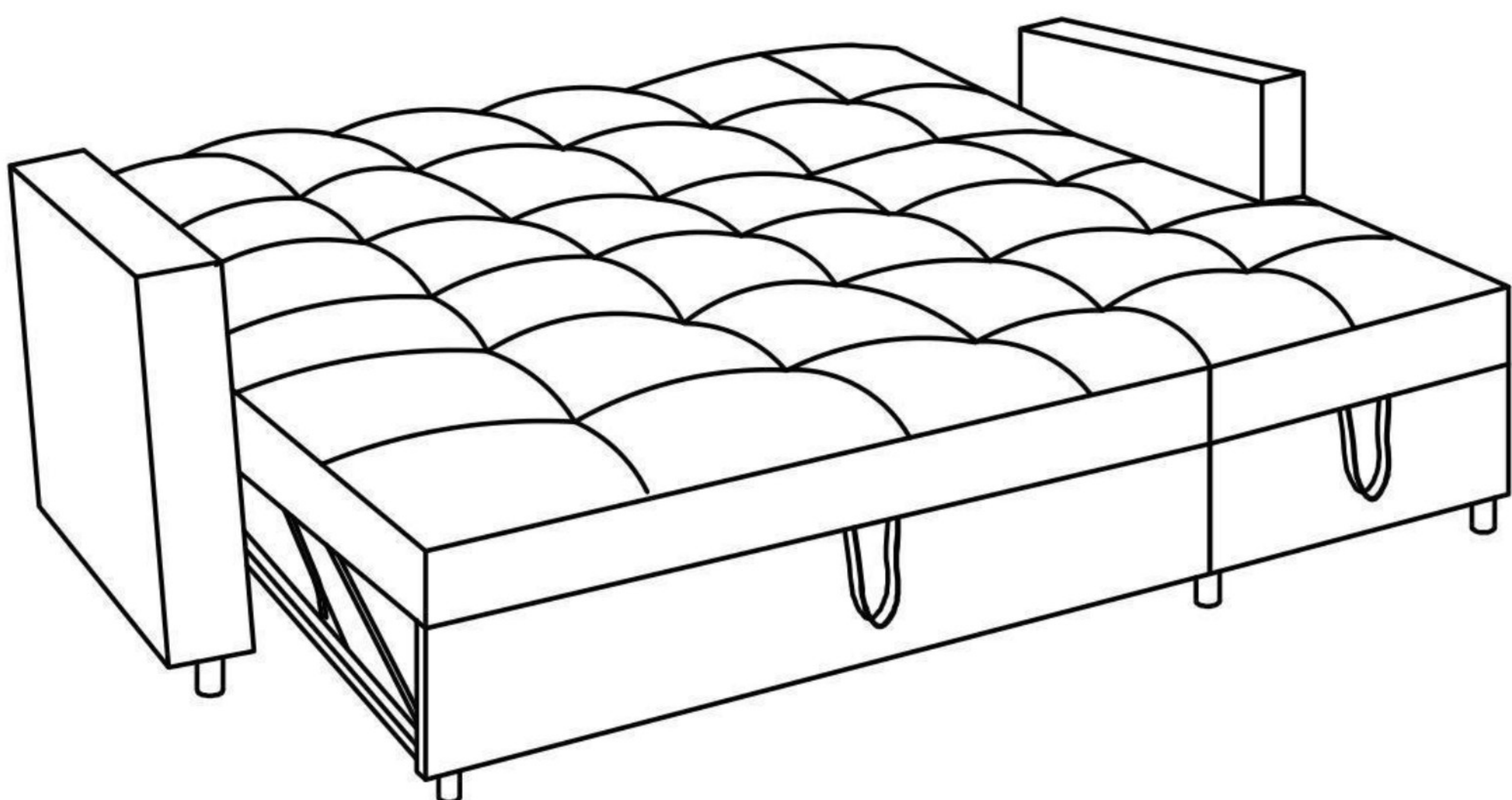

**FINISH / TERMINER**

IT IS AVAILABLE FOR PEOPLE TO CHANGE THE CHAISE DIRECTION FROM LEFT TO RIGHT. / IL EST DISPONIBLE AUX PERSONNES DE CHANGER LA DIRECTION DE CHAISE DE GAUCHE À DROITE.