

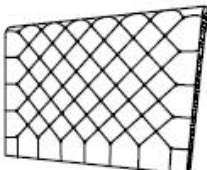

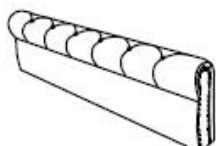









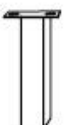



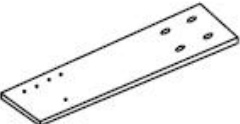

ITEM#:B2029K

ASSEMBLY INSTRUCTION

A*1 	B*1 	C*2 	D*26 
E*2 	F*4 	G*39 	H*26 
I*2 	J*2 	K*1 	L*14  M8*25mm
M*16  M8*35mm	N*8  M8*90mm	O*16 	P*12 
Q*12 	R*1 	S*1 	T*8 

NOTE:UNIT SHOULD BE ASSEMBLED BY TWO OR MORE PEOPLE
DO NOT TIGHTEN ANY BOLTS UNTIL ALL BOLTS HAVE BEEN STARTED

MADE IN CHINA
FABRIQUÉ EN CHINE

1of4

ITEM#:B2029K

1

Please check the diagram and know which height you want the headboard to be. There are three choice heights to choose from: For the highest height (73...) Place the double sided bolt (H) into holes 2 and 3, make sure two bolts are placed per row. For the middle height (69...) please put the bolts into holes 1 and 2.

Veillez vérifier le diagramme et sachez quelle hauteur vous voulez que votre tête de lit soit. Vous avez trois choix de hauteur. Pour la hauteur la plus élevée (73 po), placez le boulon double face (H) dans les trous 2 et 3, assurez-vous que deux boulons sont placés par rangée. Pour la hauteur moyenne (69 po), veuillez mettre les boulons dans les trous 1 et 2.

NOTE: UNIT SHOULD BE ASSEMBLED BY TWO OR MORE PEOPLE, DO NOT TIGHTEN ANY BOLTS UNTIL ALL BOLTS HAVE BEEN STARTED

REMARQUE : L'UNITÉ DEVRAIT ÊTRE ASSEMBLÉE PAR DEUX PERSONNES OU PLUS. NE PAS SERRER LES BOULONS AVANT QUE TOUS LES BOULONS SOIENT EN PLACE.

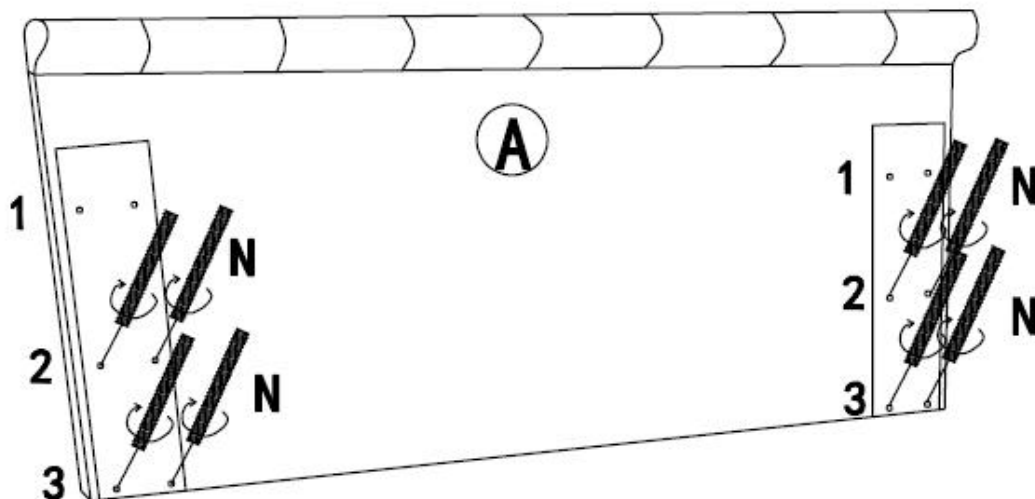

2

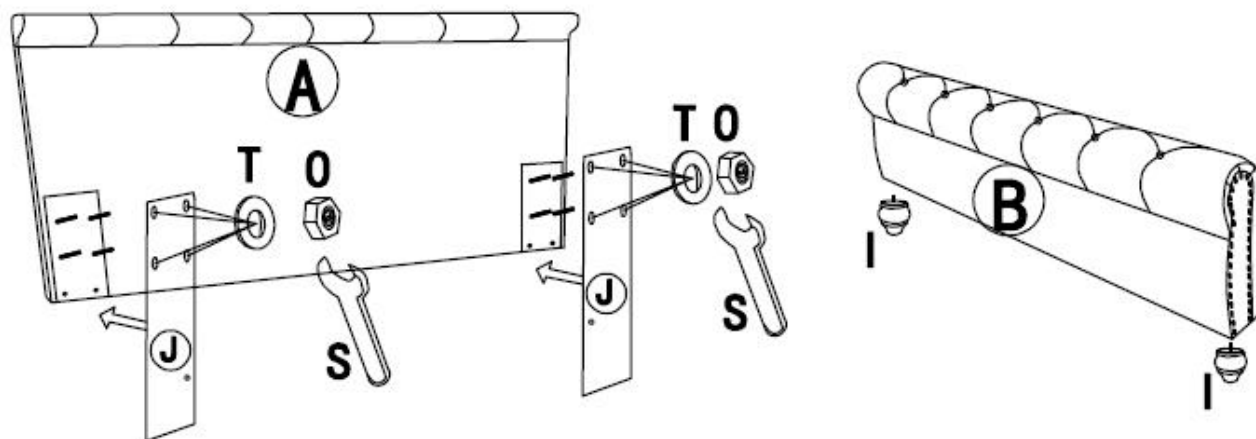

ITEM#:B2029K

3

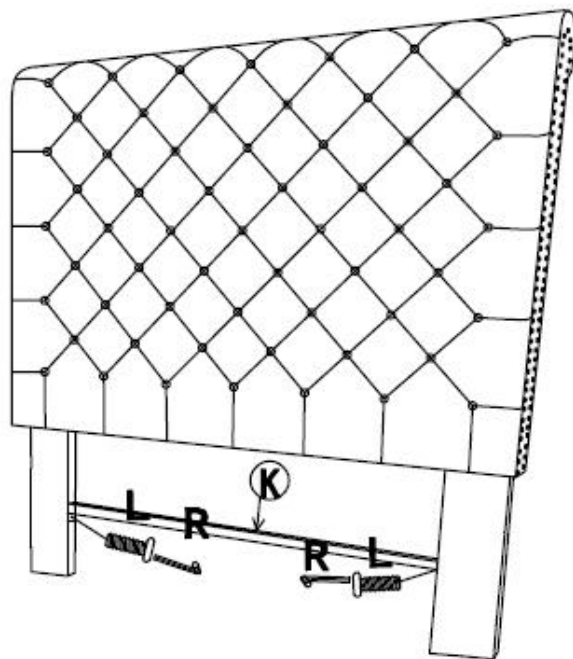

4

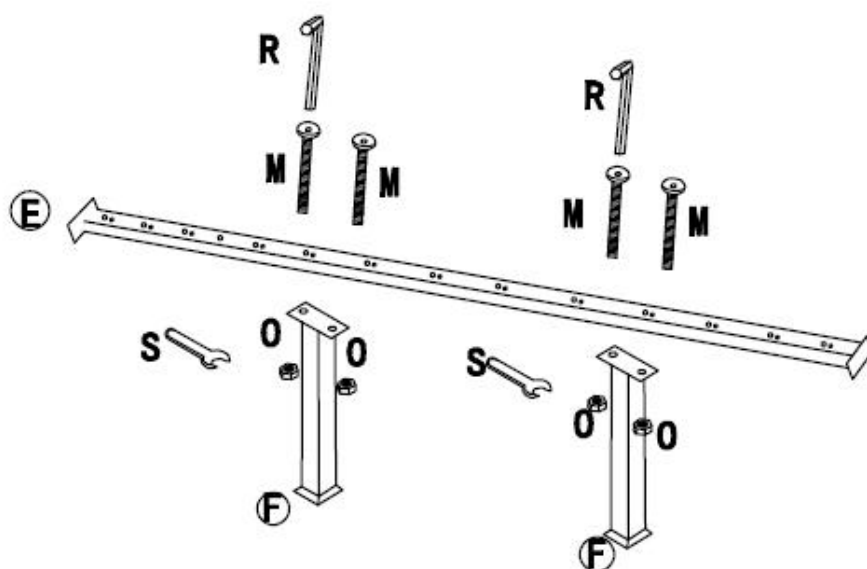

MADE IN CHINA
FABRIQUÉ EN CHINE

3of4

ITEM#:B2029K

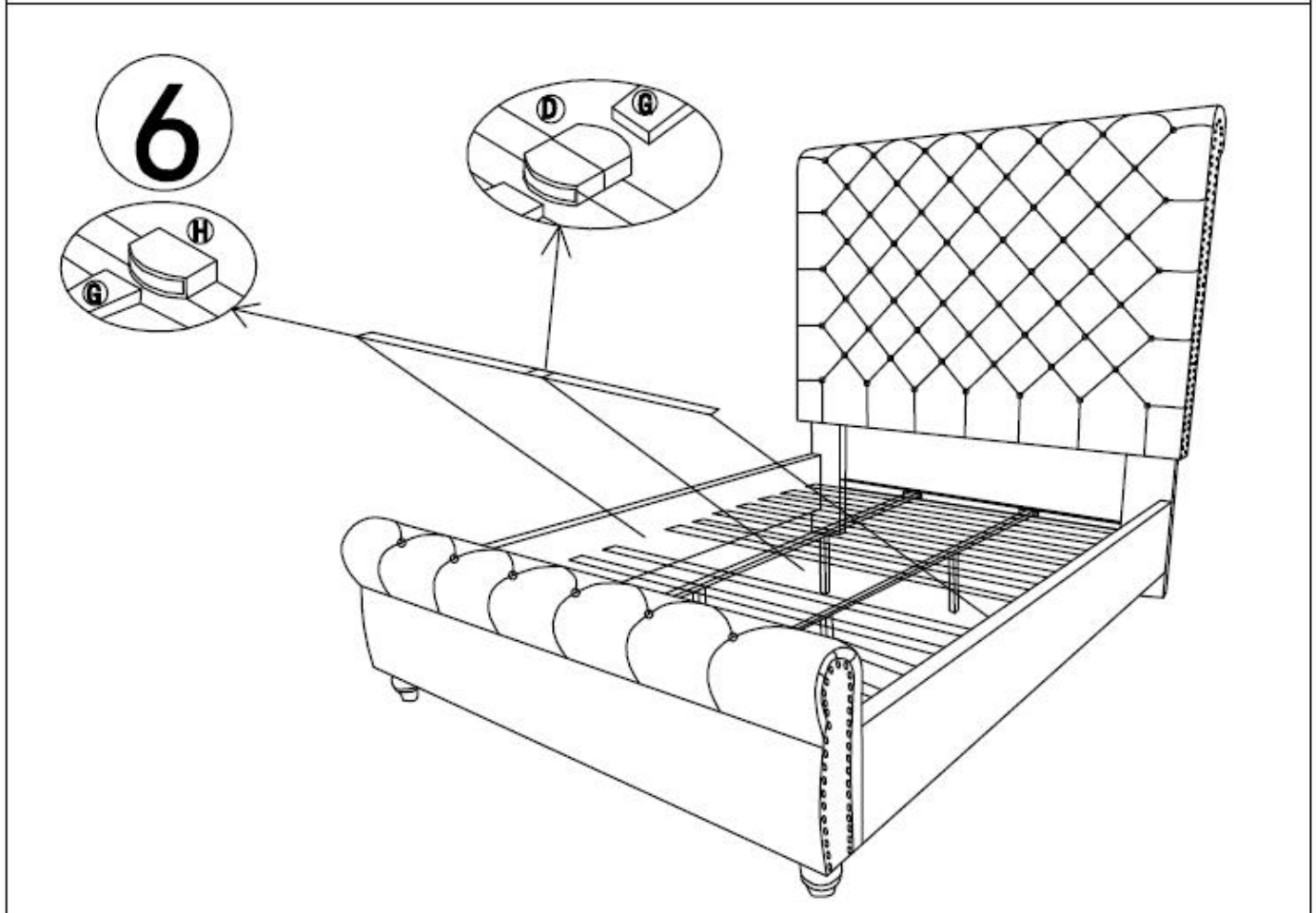
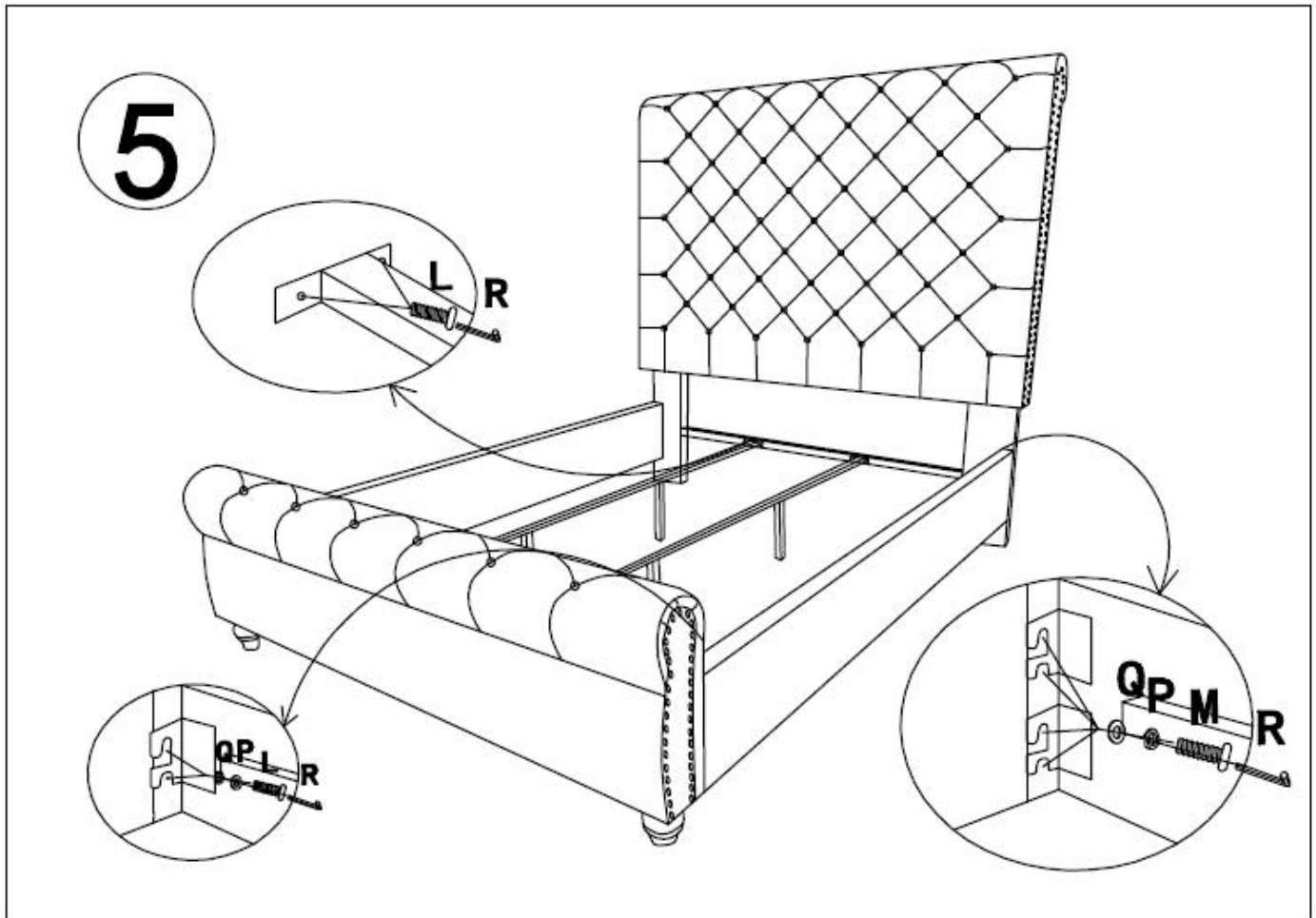

MADE IN CHINA
FABRIQUÉ EN CHINE