

BRASSEX INC.

THE FURNITURE PEOPLE
SINCE 1986

**INSTRUCTIONS D'ASSEMBLAGE
ASSEMBLY INSTRUCTIONS**

2195 BLK/WH DESK BLACK (LPL)

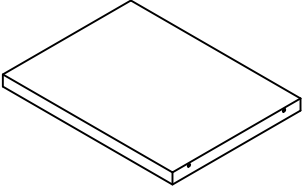
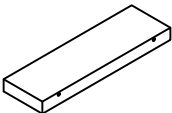
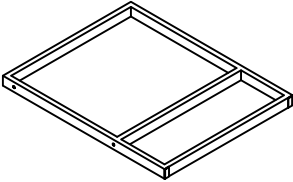
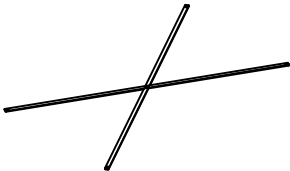

LISTE DES PIÈCES PARTS LIST

NO. / N°	IMAGE	DESCRIPTION	QUANTITÉ / QTY
1		TOP PANEL PANNEAU DE SURFACE	1
2		TOP PANEL PANNEAU DE SURFACE	2
3		METAL LEG PATTE EN METAL	2
4		SUPPORT BAR BARRE DE SOUTIEN	1

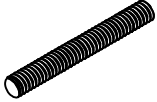
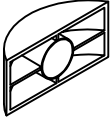
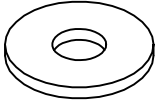
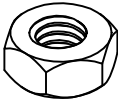

LISTE DES PIÈCES PARTS LIST

PART NO.	IMAGE	DESCRIPTION	QUANTITY
A		BARREL NUT - 1/2" " ÔÛUWÖÖÄÖEUPÄÄÄÄ	4
B		THREADED ROD -1/4" X 4 1/8" VÖÖÄÖSÖV" ÖÄÄÄÄÄÄÄÄÄ	4
C		NUT - 1 3/8" " ÔÛUWÄÄÄÄÄÄ	4
D		METAL WASHER - 5/8" ÜUPÖÖŠŠÖÖÄÄ " VÖÖÄÄÄÄÄ	4
E		HEX NUT - 1/4" X 3/8" " ÔÛUWÄÄÄÖÖUPÖÖŠŠÖÖÄÄÄÄÄÄÄÄ	4

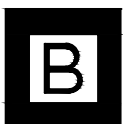

LISTE DES PIÈCES PARTS LIST

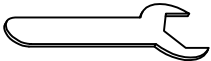
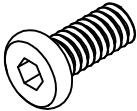
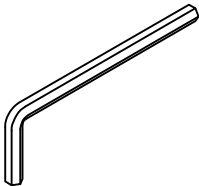
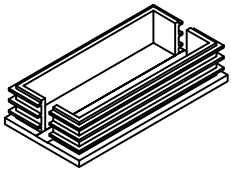
PART NUMBER	IMAGE	DESCRIPTION	QUANTITY
F		SPANNER ÔŠ" ÁP ÕŠÖÙÒ	1
G		ASSEMBLING BOLT - 5/8" BOULON D'ASSEMBLAGE - 5/8"	4
H		HEX KEY ÔŠ" ÁP ÕYÖÙP ÕŠÒ	1
I		FLOOR PROTECTOR - 1 1/2" X 3/4" PROTECTEUR DE PLANCHER - 1 1/2" X 3/4"	4



INSTRUCTIONS D'ASSEMBLAGE

ASSEMBLY INSTRUCTIONS

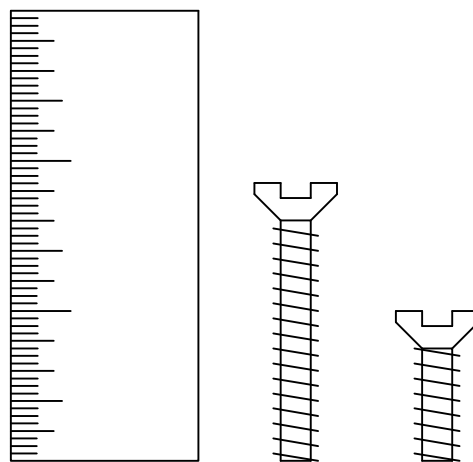

OUTIL DE VÉRIFICATION DE DIMENSIONS DES PIÈCES
HARDWARE DIMENSIONS VERIFICATION TOOL

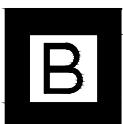
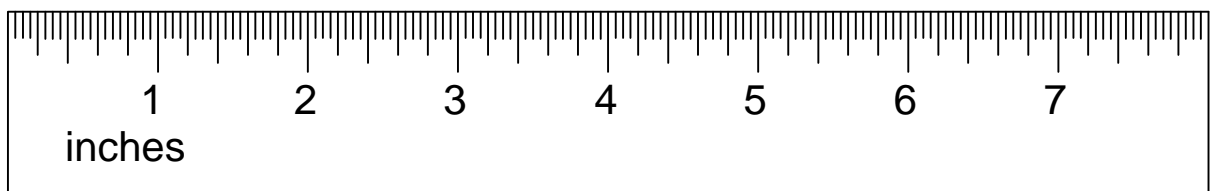

BRASSEX INC.
THE FURNITURE PEOPLE
SINCE 1986

INSTRUCTIONS D'ASSEMBLAGE

ASSEMBLY INSTRUCTIONS

ÉTAPE / STEP 1

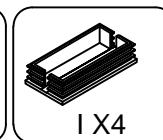
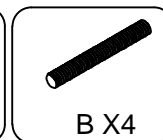
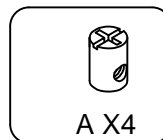
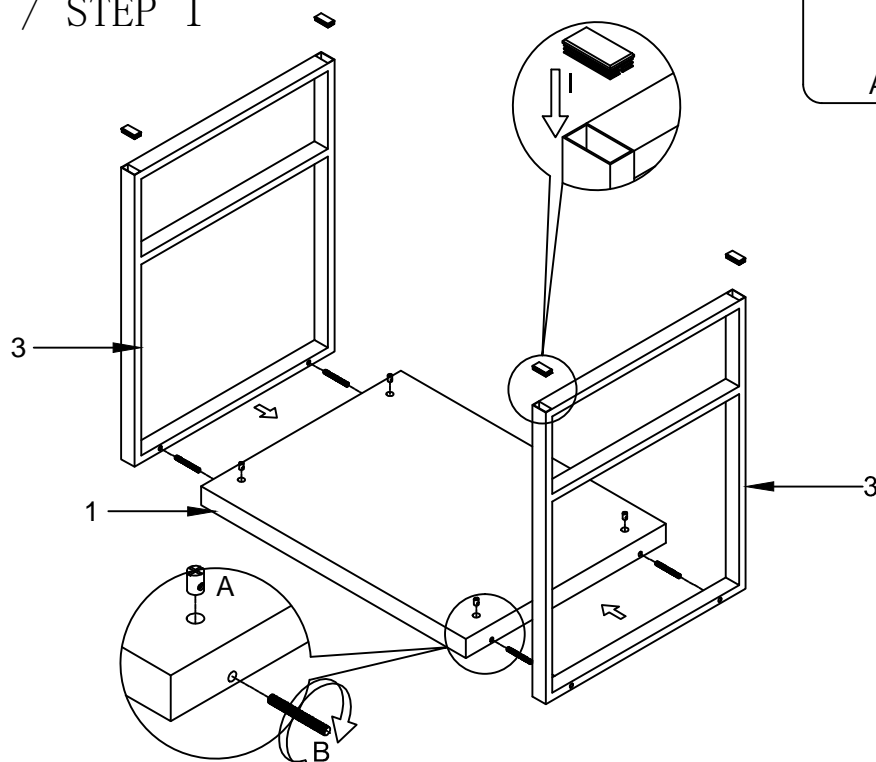

ÉTAPE / STEP 2

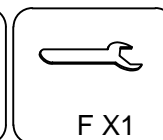
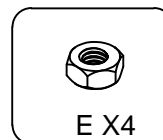
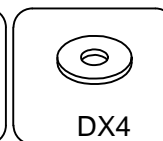
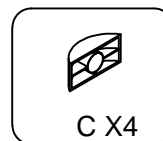
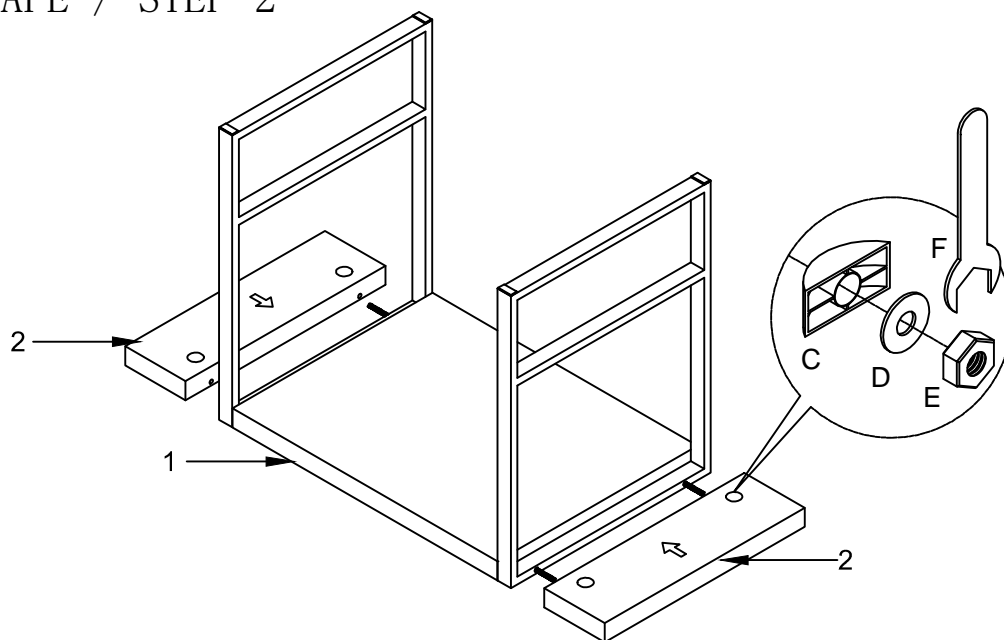

BRASSEX INC.
THE FURNITURE PEOPLE
SINCE 1986

INSTRUCTIONS D'ASSEMBLAGE ASSEMBLY INSTRUCTIONS

ÉTAPE / STEP 3

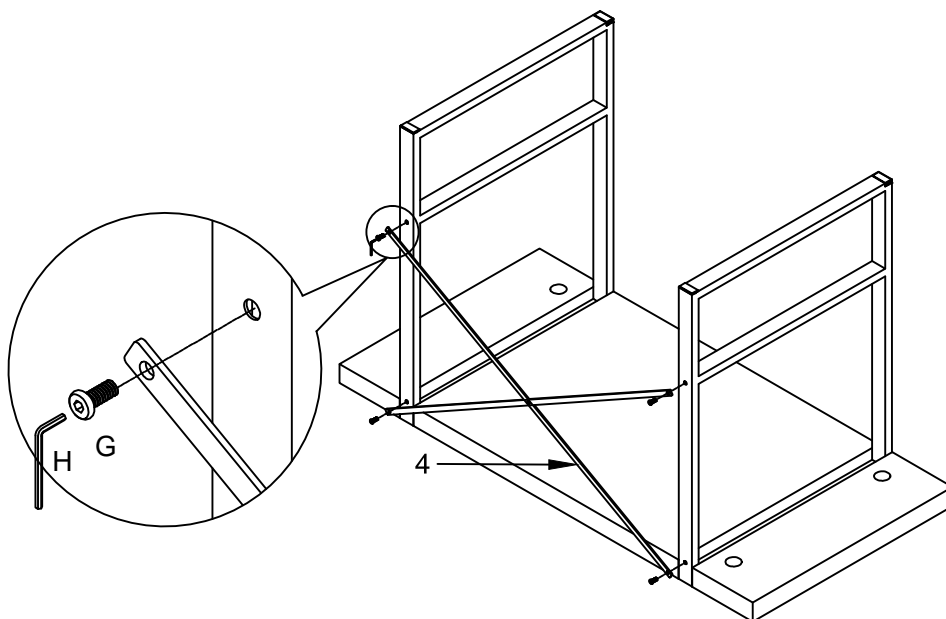
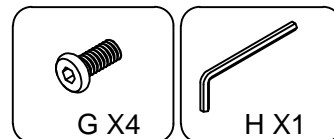

BRASSEX INC.
THE FURNITURE PEOPLE
SINCE 1986

INSTRUCTIONS D'ASSEMBLAGE

ASSEMBLY INSTRUCTIONS

ÉTAPE / STEP 4

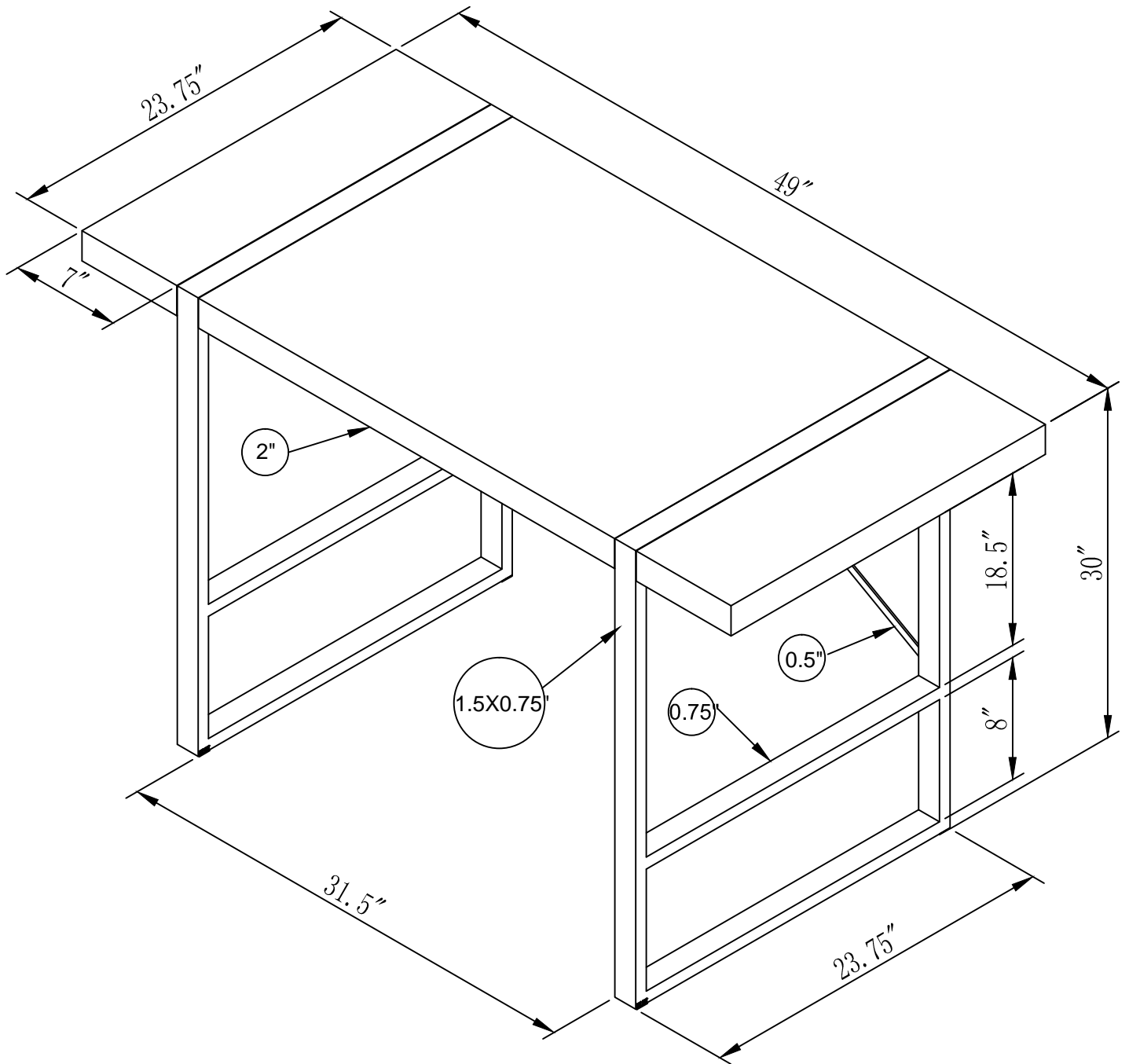

BRASSEX INC.
THE FURNITURE PEOPLE
SINCE 1986