

ASSEMBLY INSTRUCTIONS

**MODEL : 40812
NIGHT STAND**

NOTE: PHILLIPS HEAD SCREW DRIVER IS REQUIRED IN THE ASSEMBLY PROCESS; HOWEVER, MANUFACTURER DOES NOT PROVIDE THIS ITEM.

STEP 1

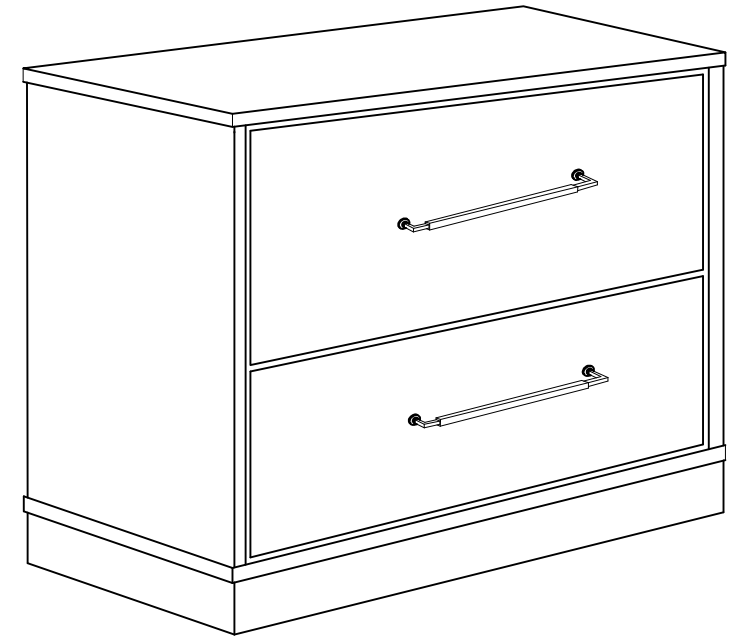
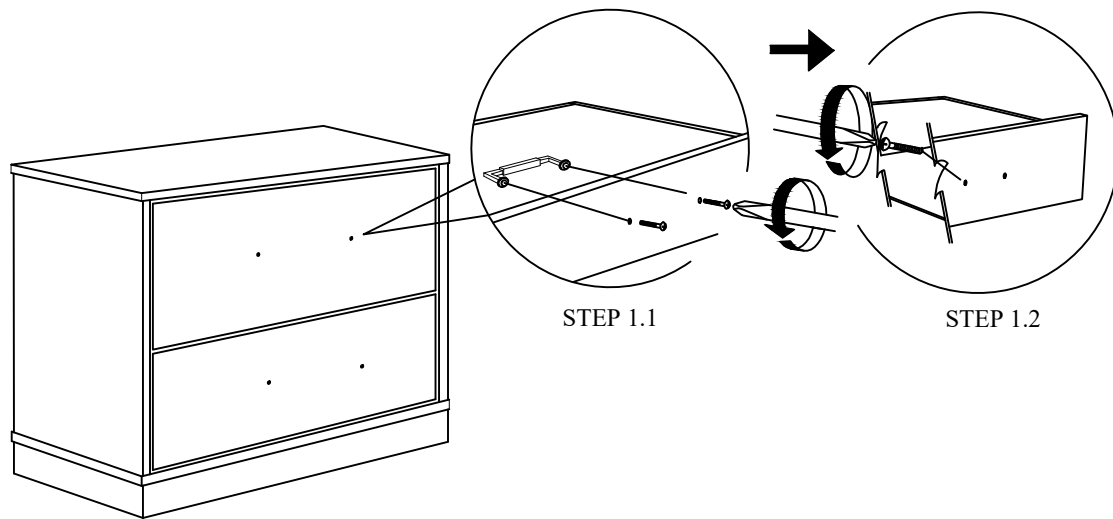

COMPLETE ASSEMBLY

NOTE : MUST TIGHTEN SCREWS PERIODCALLY WITH USE SCREW WILL BECOME LOOSE CHECK TIGHTNESS OF ALL SCREW EVERY 6-8 WEEKS.

INSTRUCTIONS D'ASSEMBLAGE

MODÈLE : 40812
LA TABLE DE NUIT

REMARQUE : UN TOURNEVIS À TÊTE PHILLIPS EST REQUIS
DANS LE PROCESSUS D'ASSEMBLAGE ; CEPENDANT, LE
FABRICANT NE FOURNIT PAS CET ARTICLE.

ÉTAPE 1

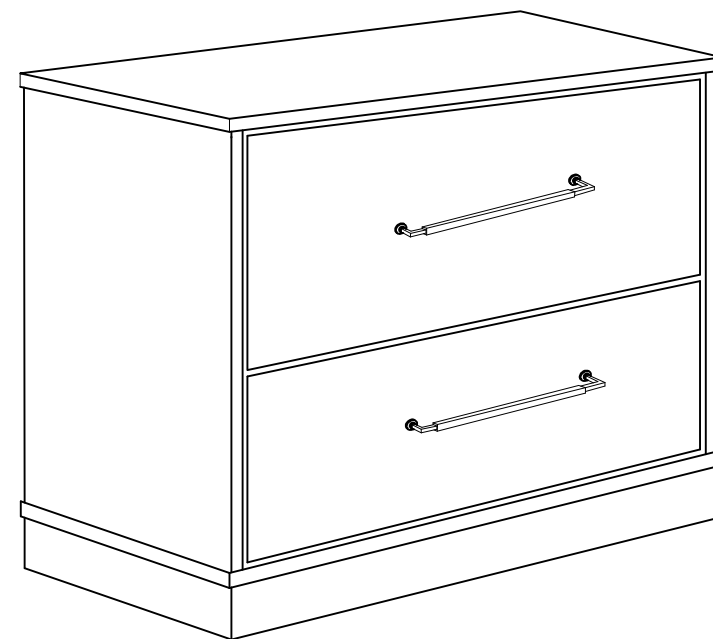
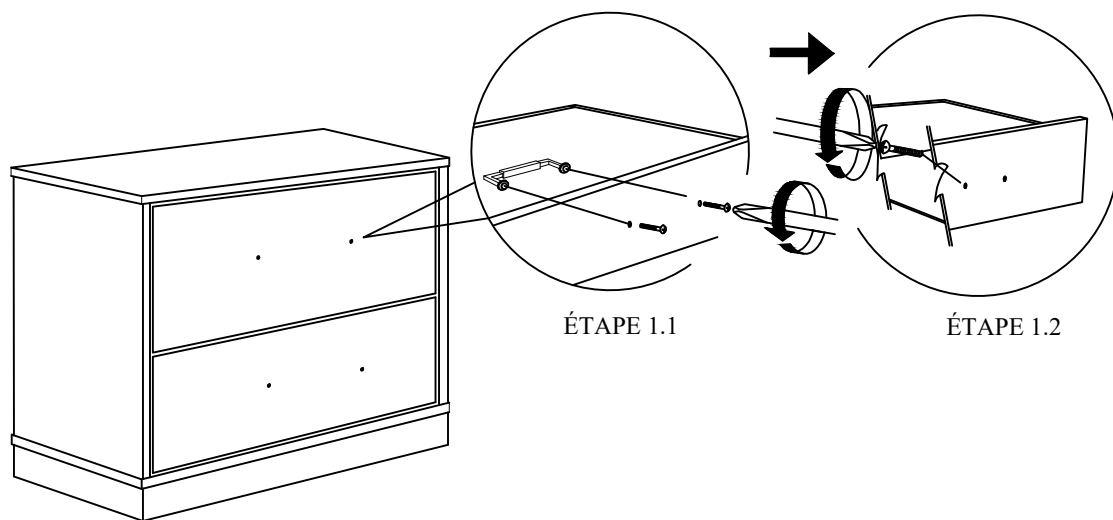

ASSEMBLAGE COMPLET

NOTE : MUST TIGHTEN SCREWS PERIODCALLY WITH USE SCREW WILL BECOME LOOSE CHECK TIGHTNESS OF ALL SCREW EVERY 6-8 WEEKS.