

# Assembly Instructions / Instructions pour l'assemblage

## Twin Full Bunk Bed / Lits Jumeaux / Lits Superposés



### SAFETY WARNING

1. Follow the information on the warnings appearing on the upper bunk end structure and on the carton. Do not remove warning label from bed.
2. Always use the recommended size mattress or mattress support, or both, to help prevent the likelihood of entrapment or falls.
3. Surface of mattress must be at least 5 in. (127 mm) below the upper edge of guardrails.
4. Do not allow children under 6 years of age to use the upper bunk.
5. Periodically check and ensure that the guardrail, ladder, and other components are in their proper position, free from damage, and that all connectors are tight.
6. Do not allow horseplay on or under the bed and prohibit jumping on the bed.
7. Prohibit more than one person on upper bunk.
8. Always use the ladder for entering and leaving the upper bunk.
9. Do not use substitute parts. Contact the manufacturer or dealer for replacement parts.
10. Use of a night light may provide added safety precaution for a child using the upper bunk.
11. Always use guardrails on both long sides of the upper bunk. If the bunk bed will be placed next to the wall, the guardrail that runs the full length of the bed should be placed against the wall to prevent entrapment between the bed and wall.
12. The use of water or sleep flotation mattresses is prohibited.
13. **STRANGULATION HAZARD**—Never attach or hang items to any part of the bunk bed that are not designed for use with the bed; for example, but not limited to hooks, belts and jump ropes.
14. Keep these instructions for future reference.

### SIZE OF MATTRESS AND FOUNDATION:

Use only mattress, which is 37 1/2" - 38 1/2" width and 74"-75" long on upper bunk (twin size). Ensure that the thickness of the mattress does not exceed 6" and that the mattress surface is at least 5" (127mm) below upper edge of guardrails.

53 3/4" - 54 1/2" width and 74" - 73" for lower bunk (full size).

Ensure that the thickness of the mattress on lower bunk is at least 8" and does not exceed 11".

### WARNING:

Adult Assembly Required. This package contains small parts. Keep away from children.

### Certified:

This bunk bed conforms to all applicable consumer product safety standards  
16 CFR PARTS 1213, 1500, 1513 and ASTM F-1427

### Replacement Parts:

Replacement parts, including additional guardrails may be obtained from any  
Brassex Inc.'s dealer.

Distributed by :

Brassex Inc  
565 Otto Rd, Mississauga,  
Ontario L5T 2V7



### AVERTISSEMENT DE SÉCURITÉ

1. Suivre la mise en garde apparaissant sur la structure du lit du haut et sur le carton. Ne pas enlever l'avertissement apparaissant sur le lit.
2. Toujours utiliser la grandeur de matelas et de support recommandée pour prévenir les possibilités d'emprisonnement ou de chutes.
3. La surface du matelas doit être au moins à 127 mm (5") du bord du rail de protection.
4. Ne pas permettre à un enfant de moins de 6 ans d'utiliser le lit supérieur.
5. Périodiquement vérifier et s'assurer que le rail de protection, l'échelle et les autres pièces sont à leur place respective et en bonne position; quelles ne sont pas endommagées et que toutes les connections sont bien serrées.
6. Ne pas jouer ni sauter sur ou sous le lit.
7. Interdire la présence de plus d'une personne sur le lit supérieur.
8. Toujours utiliser l'échelle pour monter et descendre du lit supérieur.
9. Ne pas utiliser de pièces de substitution. Contacter le manufacturier ou le détaillant pour obtenir des pièces de remplacement.
10. Utilisation d'une vieilleuse ajouterait une précaution de sécurité pour les enfants utilisant le lit supérieur.
11. Toujours utiliser les rails de protection sur les deux côtés longs du lit supérieur. Si le lit superposé a été placé le long d'un mur, le rail de protection qui est de pleine longueur du lit doit être placé le long du mur pour éviter l'emprisonnement entre le lit et le mur. (Ceci s'applique seulement au lit superposé sans deux rails de protection pleine longueur)
12. L'utilisation de matelas d'eau ou de flotation est interdite.
13. **RISQUE D'ÉTRANGLEMENT**-Ne rien attacher ou suspendre au lit superposé tout item qui n'est pas conçu à cet usage, par exemple et sans limite les crochets, ceintures, cordes à danser, etc.
14. Garder ces instructions pour références futures.

### FORMAT DES MATELAS ET BASE:

Utiliser seulement un matelas de 37 1/2" - 38 1/2" de largeur et 74"-75" de longueur sur le lit du haut (format jumeaux). S'assurer que l'épaisseur du matelas n'exécède pas 6" et que la surface est à moins de 5" (127mm) du bord des rails de protections.

53 1/2" - 54 1/2" de largeur et 74" - 75" pour la couchette inférieure (tallière/elle).

S'assurer que l'épaisseur du matelas sur la couchette inférieure est d'au moins 8" et ne dépasse pas 11".

### ATTENTION:

Un adulte doit procéder à l'assemblage. Ce paquet contient de petites pièces et doit être tenu loin de la portée des enfants.

### Certification:

Ce lit superposé est conforme aux standards de sécurité applicables aux produits de consommation – 16 CFR PARTS 1213, 1500, 1513 et ASTM F-1427

# ASSEMBLY INSTRUCTIONS

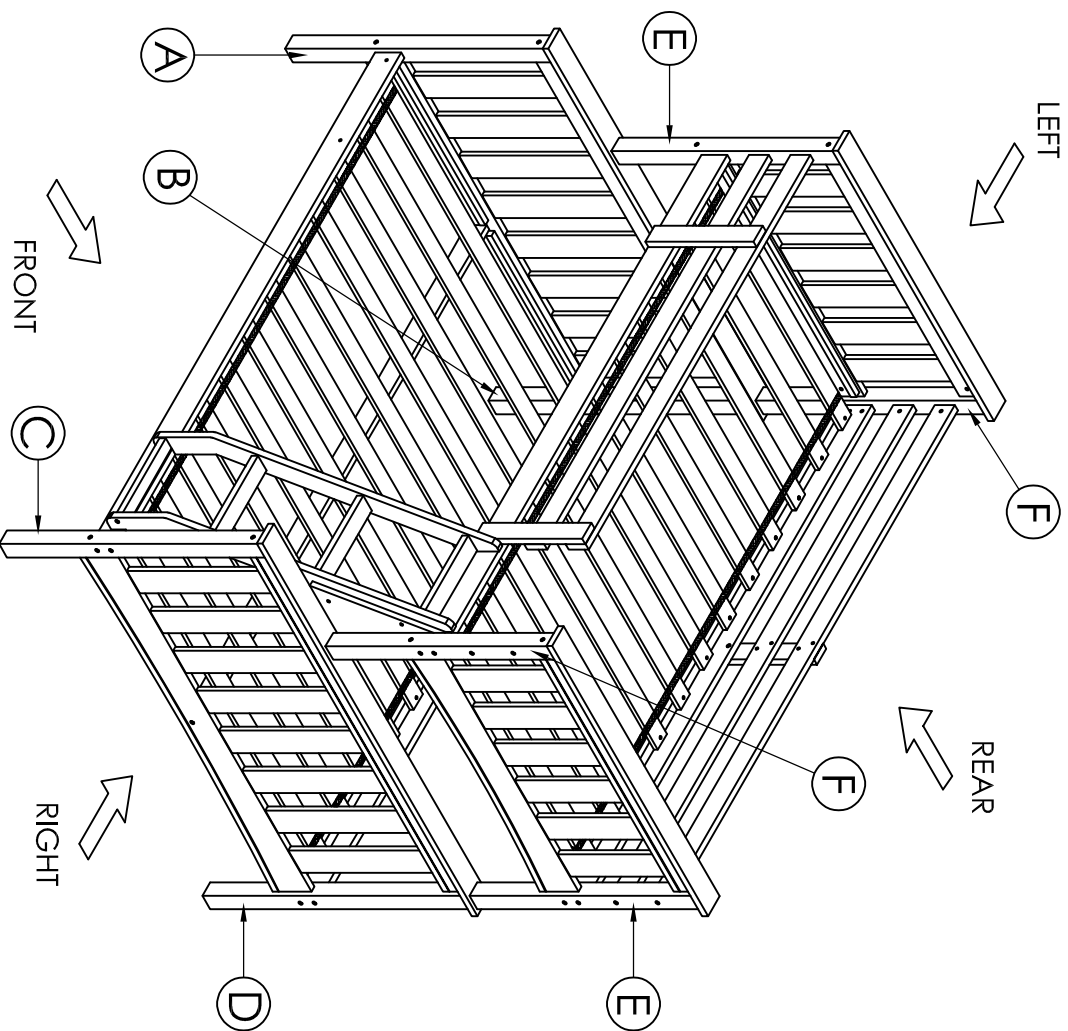

### ASSEMBLY TIPS











1. Remove hardware from box and sort by size.
2. Please check to see that all hardware and parts are present prior start of assembly.
3. Please follow attached instructions in the same sequence as numbered to assure fast and easy assembly.

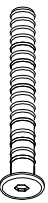

### Warning!

1. Don't attempt to repair or modify parts that are broken or defective. Please contact the store immediately.
2. This product is for home use only and not intended for commercial establishments.

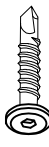
### HARDWARE LIST

1		38 PCS	7		40 PCS
JCBC M6 x 100mm		10 PCS	8		48 PCS
2		8 PCS	9		4PCS
JCBC M6 x 60mm		16 PCS	10		2PCS
3		50 PCS	11		2PCS
JCBC M6 x 30mm		2 PCS	12		2PCS
4			JCN NUT		
JCBC-W M6 x 30mm					
5					
WOOD SCREW 4.0 x 30mm					
6					
WOOD SCREW 3.5 x 16mm					

COMPONENT LIST

A	1 PC 1	1 PC I	
B	1 PC 1	1 PC I	
C	1 PC 1	1 PC J	
D	1 PC 1	1 PC J	
E	2 PCS 2	1 PC K	
F	2 PCS 2	1 PC L	
G	1 PC 1	1 PC M	
H	1 PC 1	1 PC N	
	1 PC 1	1 PC O	
	2 PCS 2	2 PCS P	

COMPONENT LIST

Q	2 PCS 2	1 PC X	
R	3 PCS 3	1 PC Y	
S	1 SET 1	1 PC Z	
T	1 SET 1		
U	1 PC 1		
V	1 PC 1		
W	3 PCS 3		

